

Jeep[®]

Jeep[®]

Jeep Wrangler



Diagnosis & Repair Manual

Water Leaks

Jeep[®]

Rev. A

Jeep[®]

General Notes

1. This manual applies to all Jeep models: 2/4 door & Hard/Soft Top
2. Before testing the vehicle, perform a review of the top system. Make sure all the latches are engaged, none of the top seals are puckered or distorted, the door seals are installed correctly, the tops are not out of alignment, etc.
3. Each leak area can have multiple root causes, as noted in the diagnosis tree. It is important to water test each repair before starting the next.
4. If a leak cannot be reproduced, it is due to the period of time the vehicle is under wet conditions. Some leaks may take hours before leaking.
5. If a leak cannot be reproduced, apply all the repairs to the applicable areas as noted in the diagnosis road map.
6. When the door is open, there is water run off from the roof that can soak the carpet. Be sure to explain to the customer that this cannot be fixed. This is an unfortunate condition with this type of vehicle, similar to convertibles.
7. It is important to understand where the leak ENDS up when diagnosing the vehicle. Where the leak ends up, does not always explain where the leak originates. Refer to the diagnosis tree when determining which repairs to perform.
8. This repair procedure does NOT cover every possible water leak on the Jeep Wrangler. The issues identified in this document are the major leaks that show up in the field.
9. Generally, a car wash is the preferred method to diagnose a vehicle.
10. If a hose is required, place on the top of the vehicle facing forward making sure water is getting to all areas. Do NOT directly spray in the area of question. This can create a “false” leak that cannot be fixed.
11. This manual is not intended to be a service manual. The content identifies the major areas of water leaks, the critical characteristics of each area and how to repair them.

READ FIRST

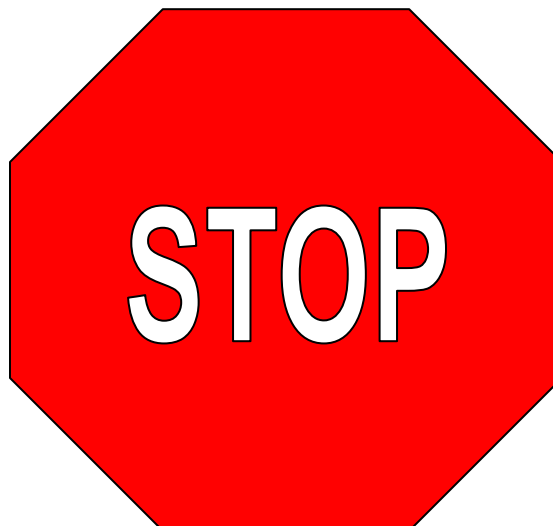

READ FIRST

Diagnosis Road Map

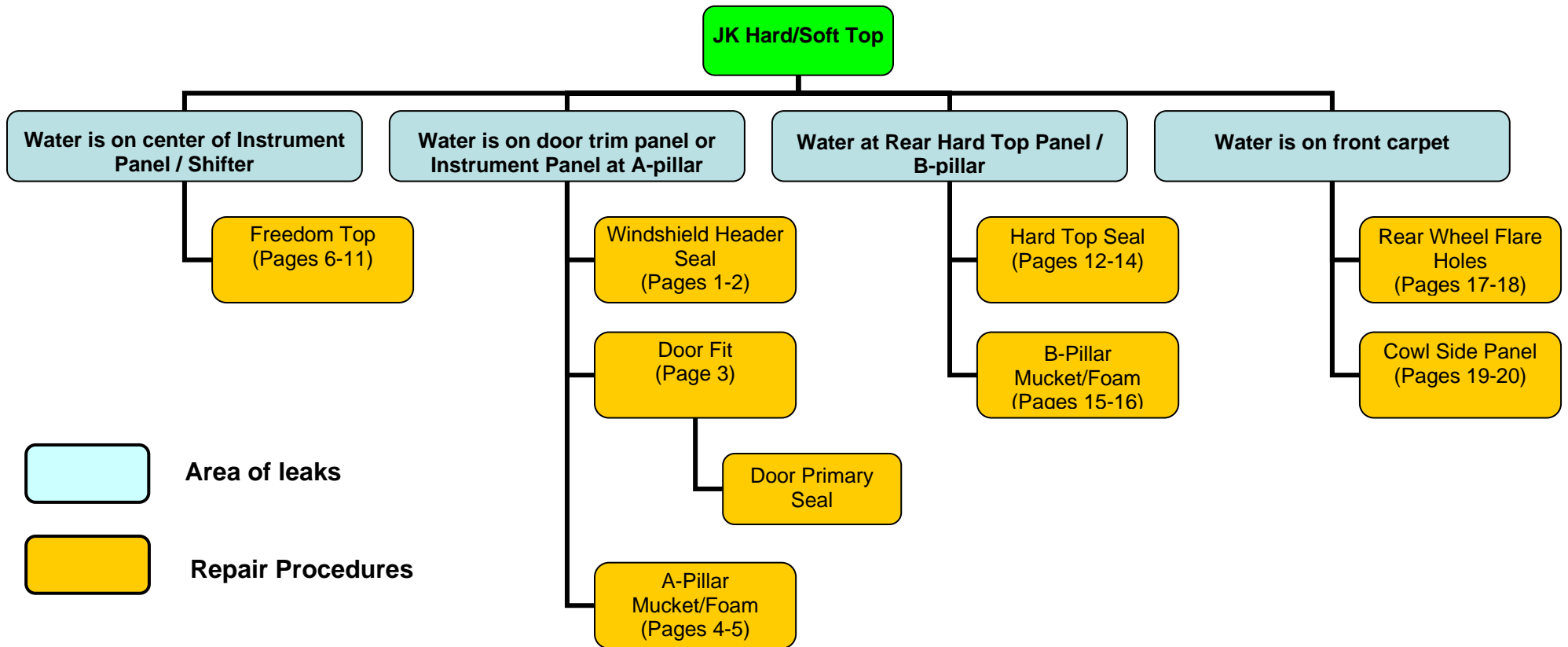

Table of Contents

I. Diagnosis Road Map	i
II. General Notes	ii
III. Water leak on Door Trim or Instrument Panel	
a) Repair procedure for Windshield Header Seal	1-2
b) Repair procedure for Door Fits	3
c) Repair procedure for A-pillar mucket/foam	4-5
IV. Water leak on Instrument Panel/Console Center	
a) Repair procedure for Freedom Panel Seal	6-11
b) Repair procedure for Freedom Panel latches	11
V. Water leak at B-plr	
a) Repair procedure for Hard Top Seal	12-14
b) Repair procedure for B-pillar Mucket	15-16
VI. Water leak on front carpet	
a) Repair procedure for rear wheel flare hole	17-18
b) Repair procedure for cowl side leaks	19-20
VII. Appendix	
a) Foam Kit	21
b) Replacement part numbers	22

Windshield Header Seal Repair Procedure

AREA OF LEAK:

- This repair procedure is applicable when water is evident on the:
 - Door trim panel
 - or
 - Instrument panel (a-pillar)



STEP 1: Remove Header Seal

- Figure 1

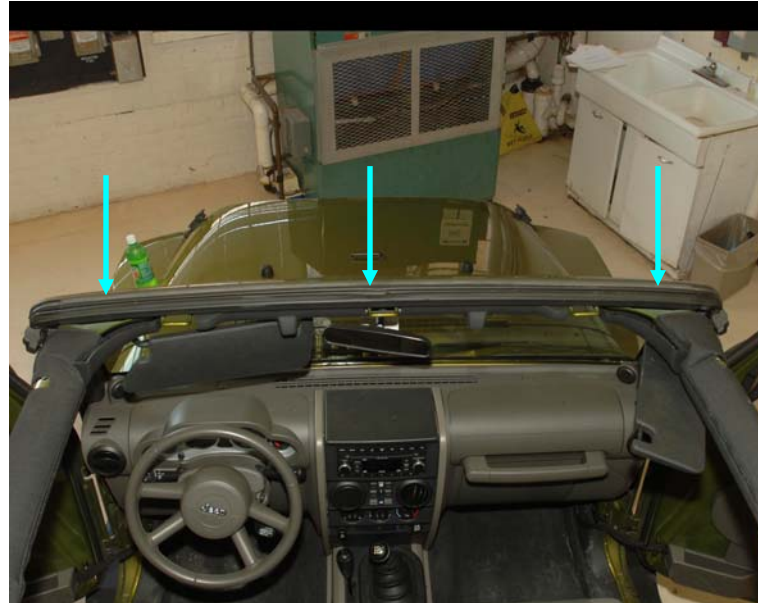

Figure 1

STEP 2: Remove/Clean Surface

- Remove all butyl and tape residue
- A rubber wheel bit can be used
- Clean surface with 3M adhesive cleaner
- Alcohol wipe entire surface and allow to dry



Figure 2

Windshield Header Seal Repair Procedure

STEP 3: Install Butyl

- **NOTE:** This operation is only applicable for vehicles built before 6/1/2008. Vehicles built after this date, should already have sealer present in this area.
- Install 4mm butyl (68027813AA) as shown (Figure 4)
- Make sure to fill in all holes, wrinkles and step offs to allow for a smooth surface to bond the tape/butyl from the new seal
- **NOTE:** Excessive amount of butyl can cause transition voids/leaks. Make sure to smooth out butyl.



Figure 3

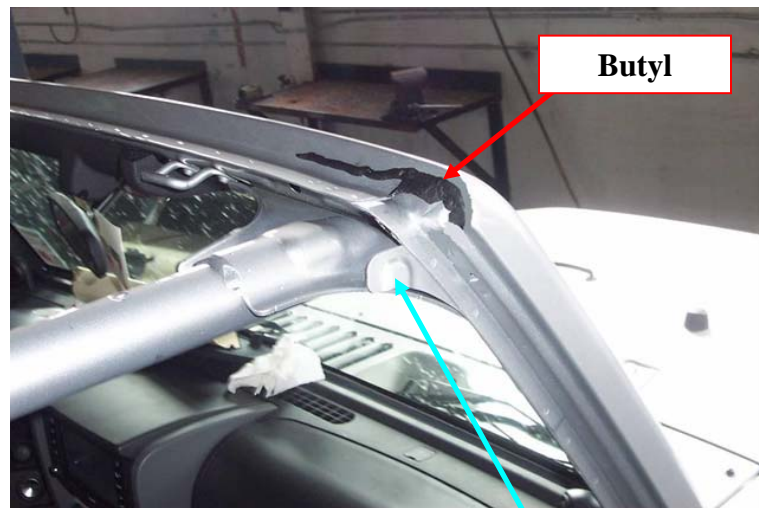

Figure 4

STEP 4: Install Seal

- Locate and install new seal, Pt #: 55397454AE
- Remove release tape and pressurize seal firmly in contact with header sheet metal to smooth out adhesive tape and butyl, starting at the ends and working toward the center. A small roller or firm finger pressure should be used to insure the tape is adhered completely from side to side, **THIS STEP IS CRITICAL**

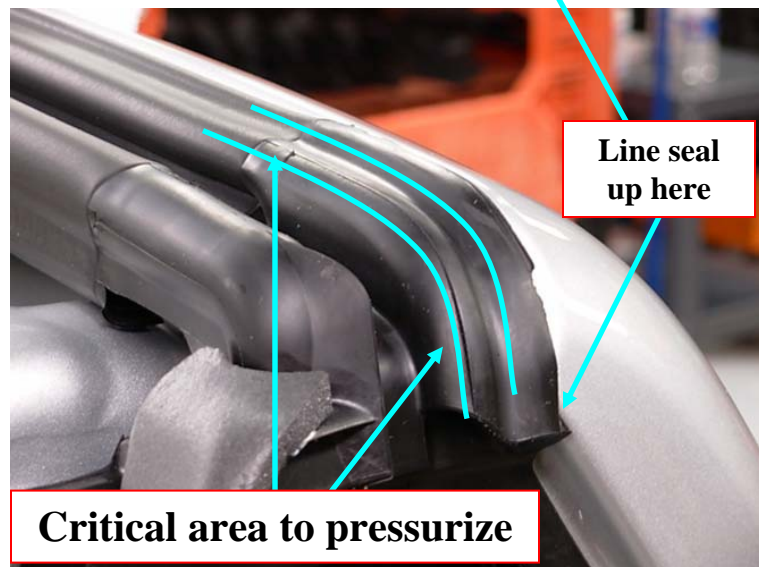

Figure 5

Door Fit Repair Procedure

AREA OF LEAK:

- This repair procedure is applicable when water is evident on the:
 - Door trim panel
 - or
 - Instrument panel (a-pillar)

STEP 1: Door Gap Checks

- Measure door gaps
- The specifications are as follows:
- The gap spec. is 5.0 +/- 2.0 mm
- The flush spec. is 0.0 +/- 2.0 mm
- If the door fit is not to spec, proceed to Step 2

STEP 2: Adjust Doors

- Adjust the door gap and flushness as described in DealerConnect> TechCONNECT under: Service info> 23 – Body> Body Structure> Gap and Flush> Specifications Service Manual

STEP 3: Replace Door Primary Seal

- If the doors are adjusted, the door seal must be replaced
- Part #: 55395274/5AN

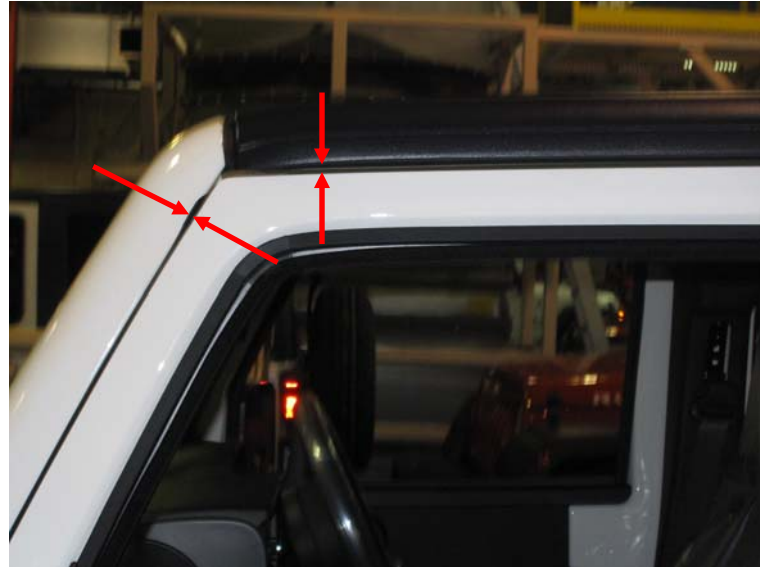

Figure 6



Figure 7

A-Pillar Foam/Mocket Repair Procedure

AREA OF LEAK:

- This repair procedure is applicable when water is evident on the:
 - Door Trim Panel



STEP 1: Header Mocket

- **NOTE:** This issue/repair applies to both hard and soft top vehicles
- Inspect the header seal mocket for the seal rolled under the freedom panel or side rail. (Figure 8)
- If the seal is folded under, remove the freedom panel or side rail and re-install making sure not to distort the mocket (Figure 9)



Figure 8



Figure 9

A-Pillar Foam/Mocket Repair Procedure

STEP 2: A-Pillar Foam

- NOTE: This issue/repair applies to both hard and soft top vehicles
- Inspect the freedom panel or side rail for damaged/missing foam (Figure 10)
- If the foam is damaged or missing, replace the foam using the foam kit (68026937AB)



Figure 10

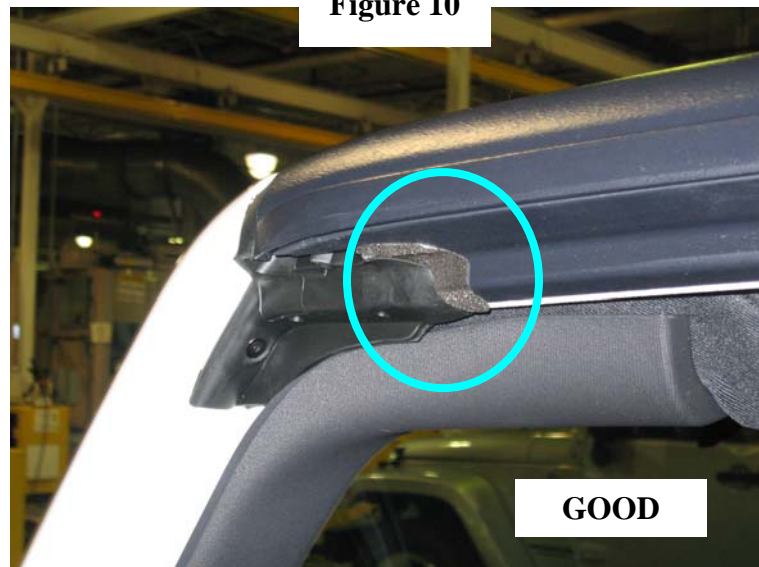

Figure 11

STEP 2: Foam Installation

- Install the foam to the freedom panel as shown in Figure 12
- The foam installation is similar for the soft top rail

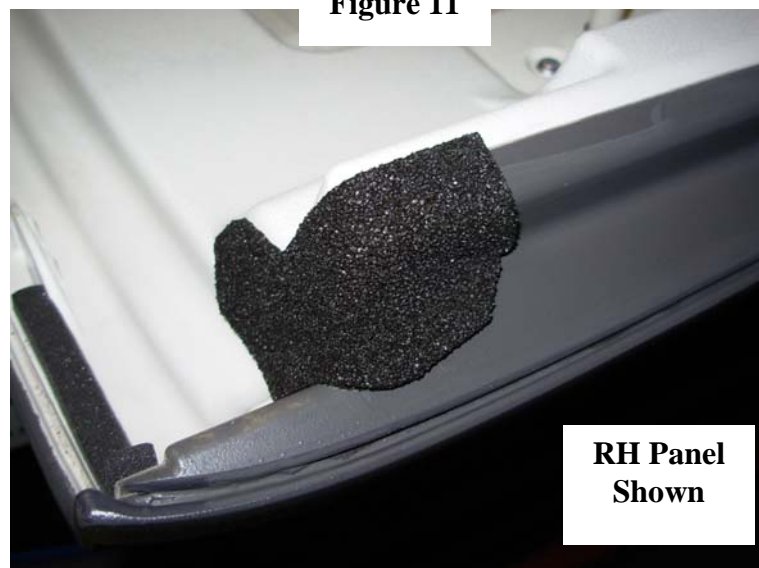

Figure 12

B-Pillar Mocket/Foam Seal Repair

AREA OF LEAK:

- This repair procedure is applicable when water is evident on the:
 - Instrument panel (Center)
or
 - Console / Shifter

RIGHT HAND FREEDOM PANEL

STEP 1: Seal Removal

- Remove seal on Right panel

STEP 2: Tape and Butyl Removal

- Remove tape and butyl residue from panel
- A rubber wheel bit can be used
- Clean Seal Surface with: 3M General Purpose Adhesive Cleaner or Kent Products Acrysol, (if available) and allow to dry completely
- Wipe seal surface with alcohol and allow to dry completely.



Figure 13

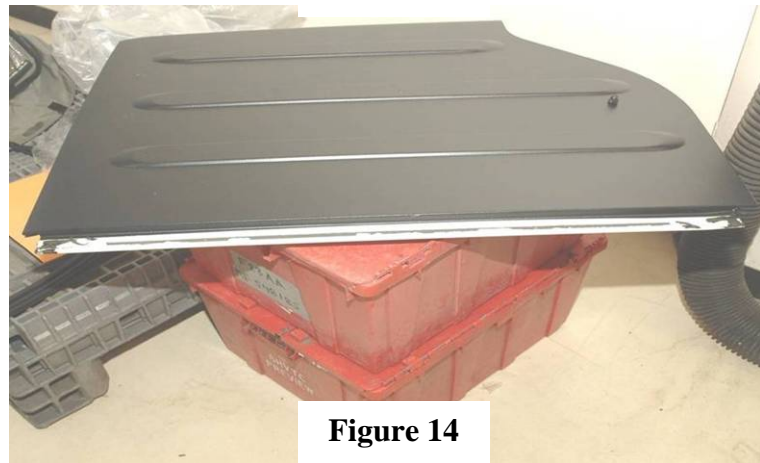

Figure 14



Figure 15

B-Pillar Mocket/Foam Seal Repair

STEP 3: Butyl Installation

- Place right hand freedom panel upside down on a covered surface to prevent scratching

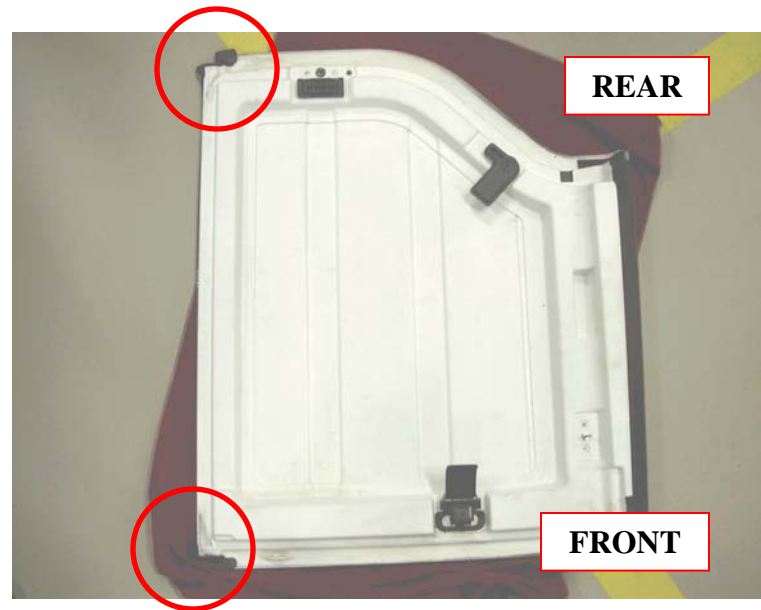

Figure 16

- Apply 4 mm diameter Butyl, Pt # 68027813AA, to Rear Notch (Figure 17)
- Note: Follow groove between panels and push butyl firmly in place

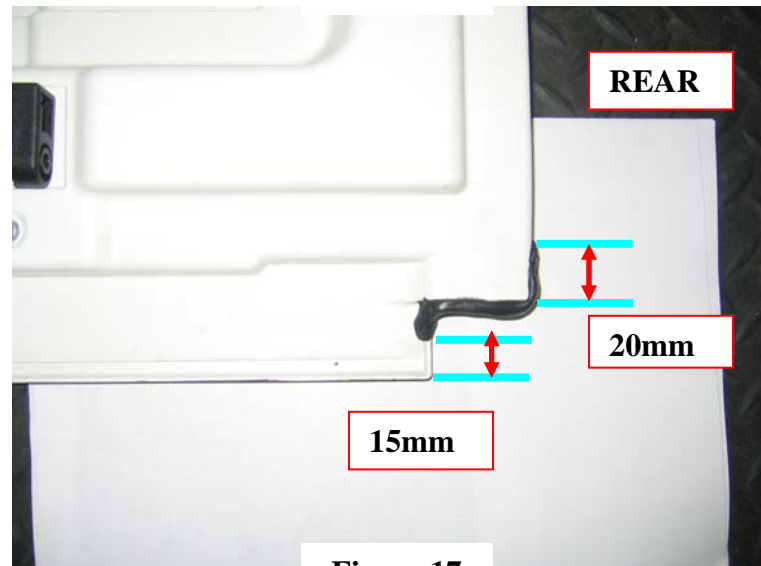

Figure 17

- Apply 4 mm diameter Butyl, Pt # 68027813AA, to Front Notch (Figure 18)
- Note: Follow groove between panels and push butyl firmly in place

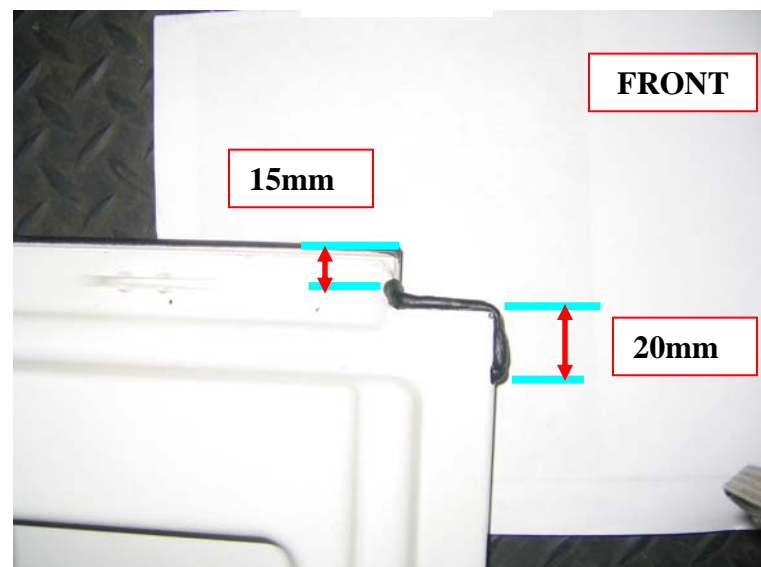

Figure 18

B-Pillar Mocket/Foam Seal Repair

STEP 4: Seal Installation

- Keep freedom panel upside down for the initial installation of the seal
- Remove tape liner from seal

NOTE: Secure the end molds first, then finish with the middle of the seal

Rear Seal Mold

- Align **REAR** edge of NEW seal, Pt # 55397095AG to Right Freedom Panel Notch.
- Compress butyl by installing seal in direction of arrows (Figure 20)
- Note: No gap between installed seal and outer edge of freedom panels. (Figure 20)

Front Seal Mold

- Align **FRONT** edge of NEW seal, Pt # 55397095AG to Right Freedom Panel Notch
- Compress butyl by installing seal in direction of arrows (Figure 21)
- Note: No gap between installed seal and outer edge of freedom panels. (Figure 21)

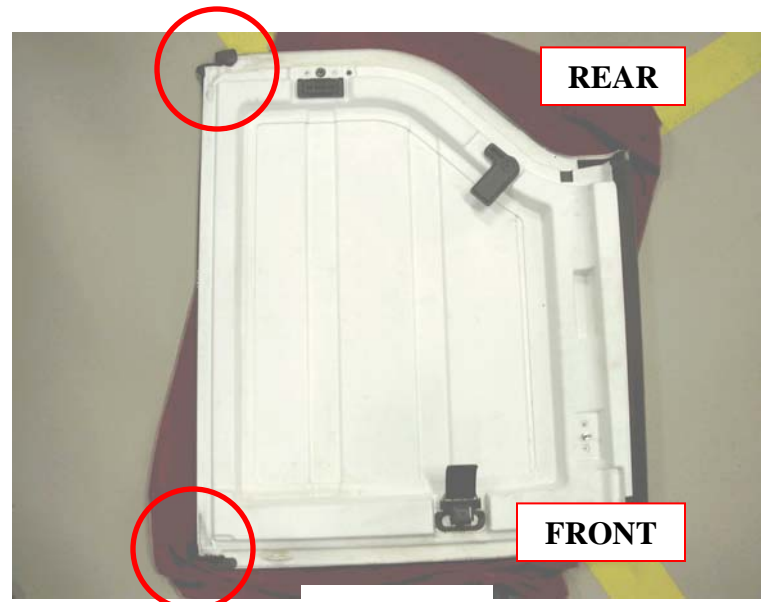

Figure 19

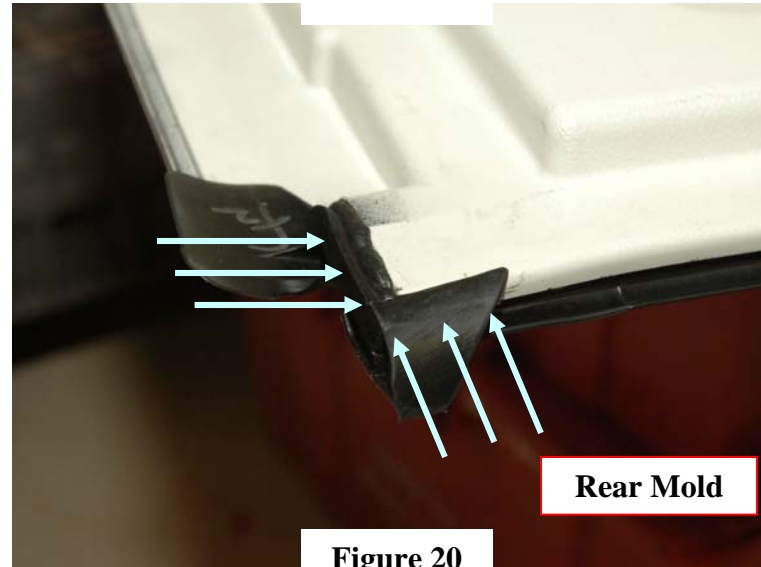

Figure 20

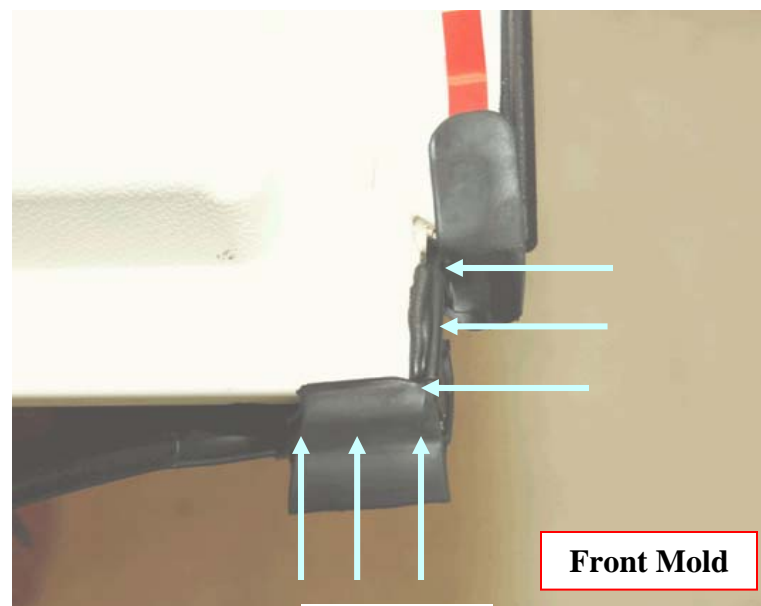

Figure 21

B-Pillar Mocket/Foam Seal Repair

STEP 5: Pressurize Seal

- Flip panel back over to complete the seal installation
- Locate seal cross car against the middle rib in the freedom panel and pressurize starting at the ends and working toward the center
- A small roller or firm finger pressure should be used to insure the seal tape is adhered from front to rear, **THIS STEP IS CRITICAL**

This photo is for reference only. Panel was cut to show rib.

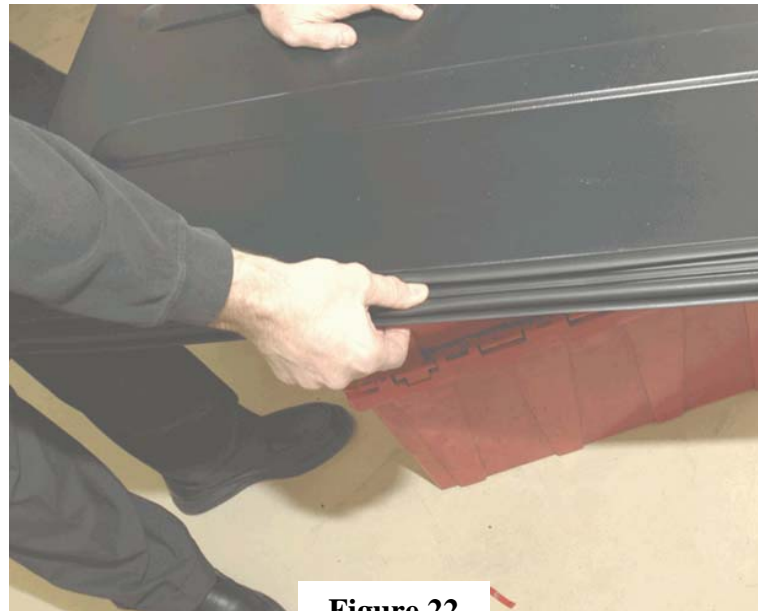

Figure 22

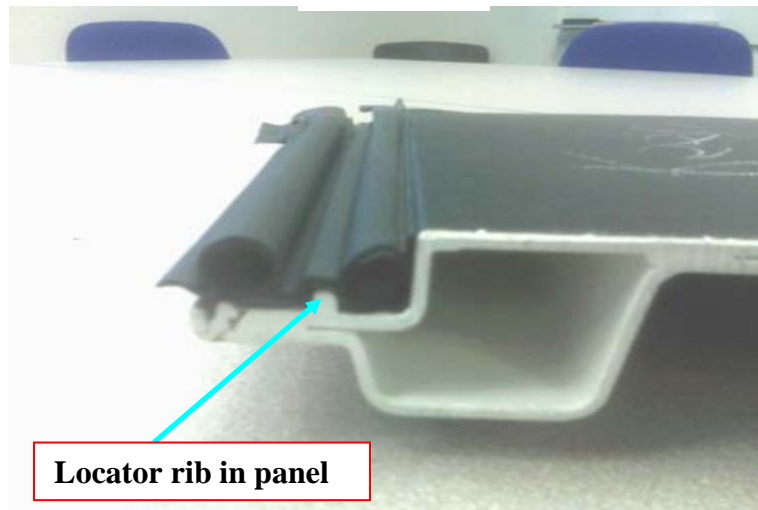

Figure 23

STEP 6: Install foam at Front

- Install **GREY** 30 X 75 mm Foam from kit (68026937AB) along trim lines of flame tip (Figure 24)
- **NOTE:** Make sure foam covers butyl completely

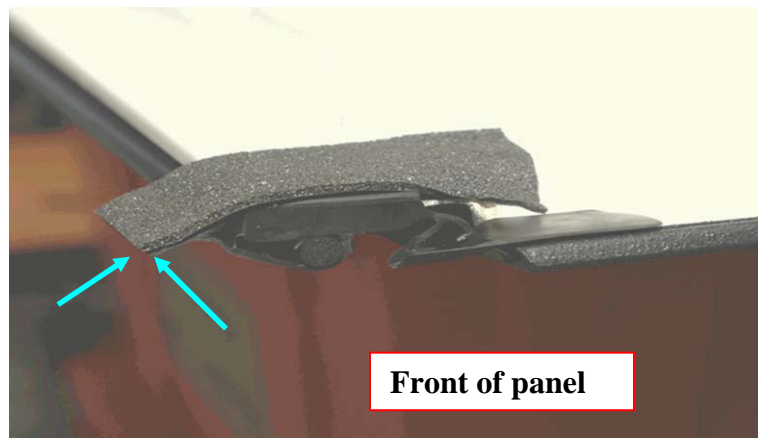
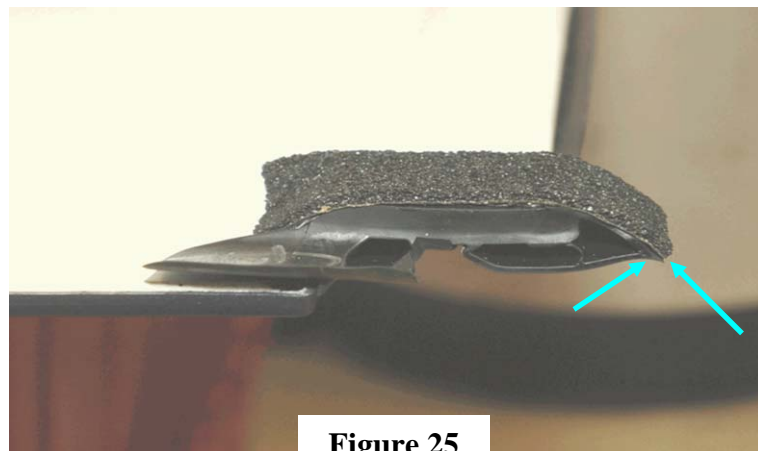

Figure 24

B-Pillar Mocket/Foam Seal Repair

STEP 7: Install foam at Rear

- Install **BLACK** 30 X 75 mm Foam from kit (68026937AB) along trim lines of flame tip (Figure 25)
- NOTE: Make sure foam covers butyl completely



LEFT HAND FREEDOM PANEL

STEP 8: Install butyl at Rear

- Place Left hand freedom panel upside down on a covered surface to prevent scratching
- Add 4mm diameter butyl, (68027813AA) to rear inboard corner groove (Figure 27)
- Note: Push butyl firmly into groove between panels until flush

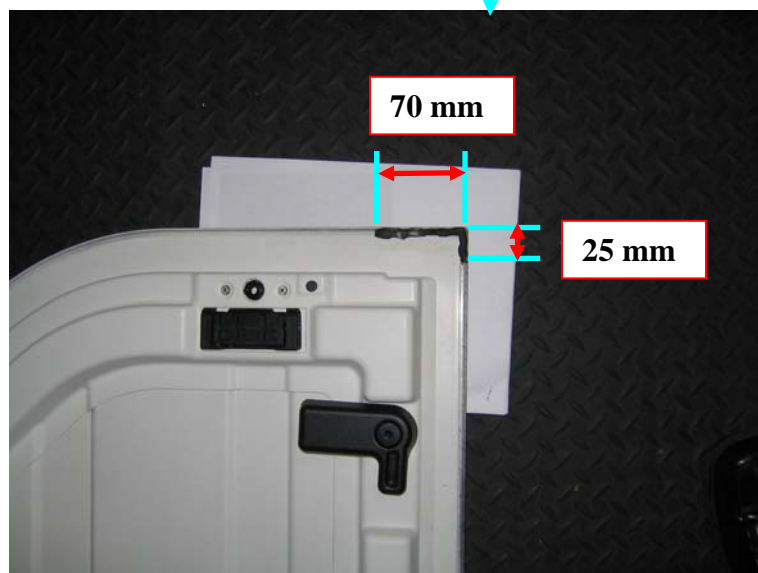
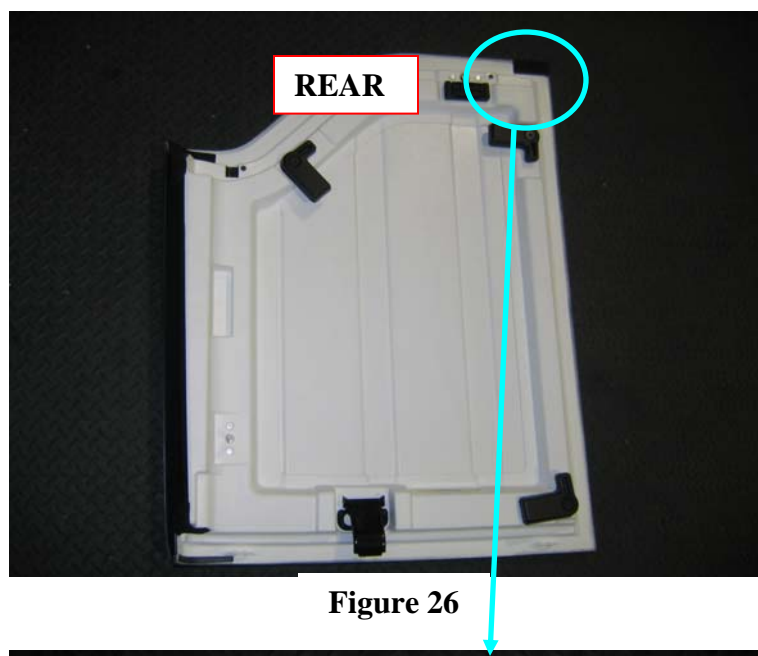

B-Pillar Mocket/Foam Seal Repair

STEP 9: Install foam at Rear

- Add 30 X 75 mm Black Foam from Kit (68026937AB) to cover butyl (Figure 28)
- NOTE: Make sure foam covers butyl completely

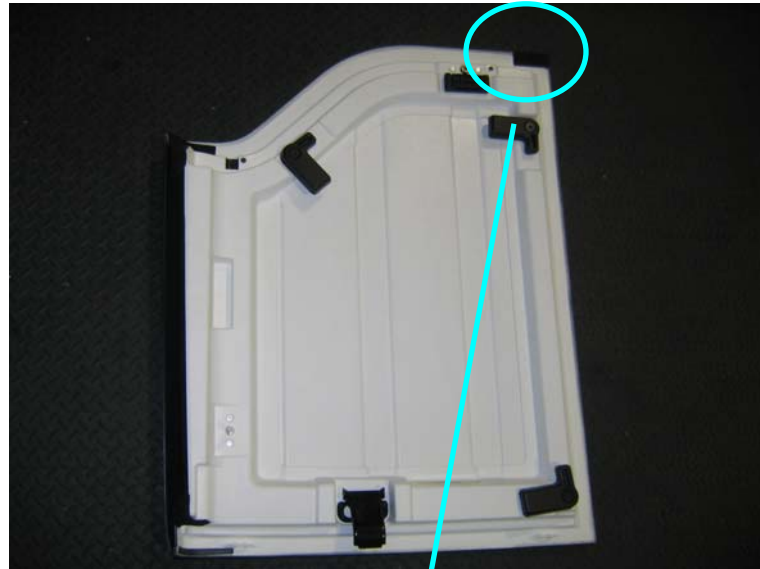

Figure 28

STEP 10: Install front latches

- NOTE: This applies to both Right and Left panels
- If the vehicle MDH is prior to 12/07/07, replace the front latches with part number 68004562AB (Figure 29)



Figure 29

B-Pillar Mocket/Foam Seal Repair

AREA OF LEAK:

- This repair procedure is applicable when water is evident on the:
 - B-pillar roll bar
 - B-pillar trim
 - Freedom panel screw holes

NOTE: Water that enters anywhere along the hard top seal can travel over to the B-pillar and leak from the hard top

STEP 1: Inspect Hard Top Seal

- Inspect for any gaps between the seal and hard top (Figure 30,31)

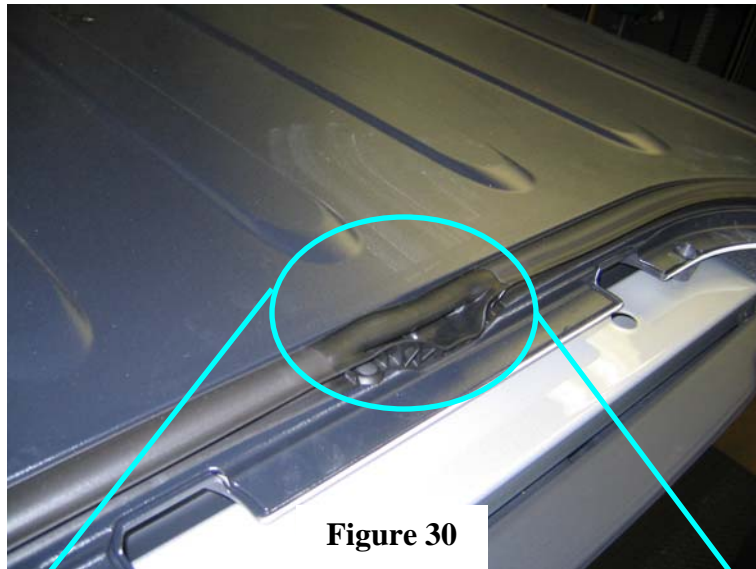

Figure 30

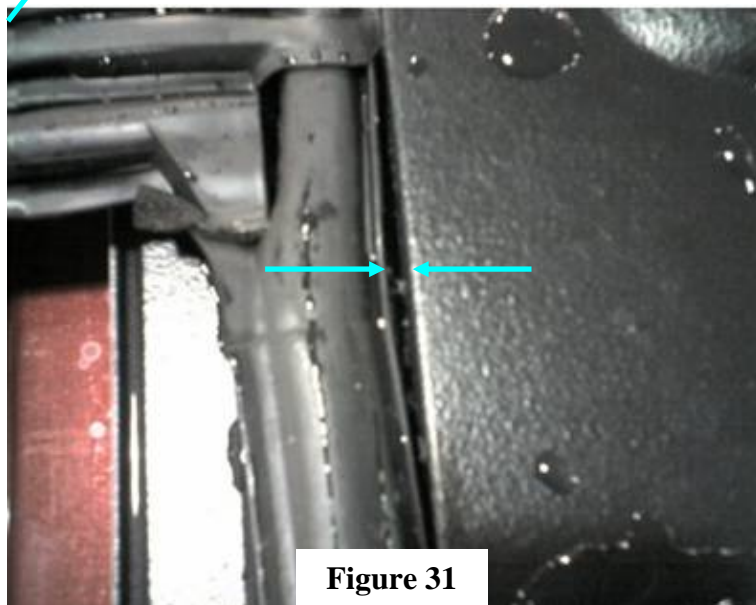
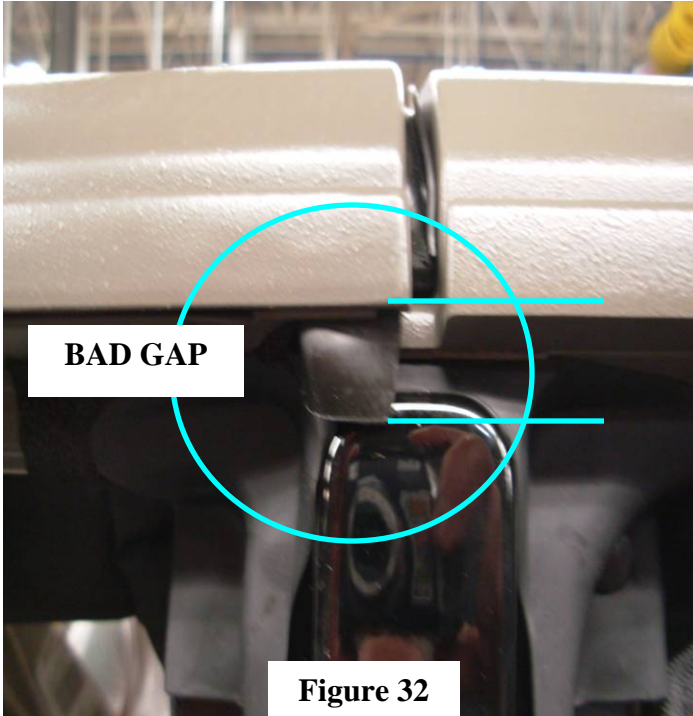

Figure 31

B-Pillar Mocket/Foam Seal Repair

STEP 1: Inspect Hard Top Seal (cont.)

- Inspect the end molds for poor installation (Figure 32)



- Inspect underneath the seal for any skips with the tape/butyl along the entire seal (Figure 34 & 35).

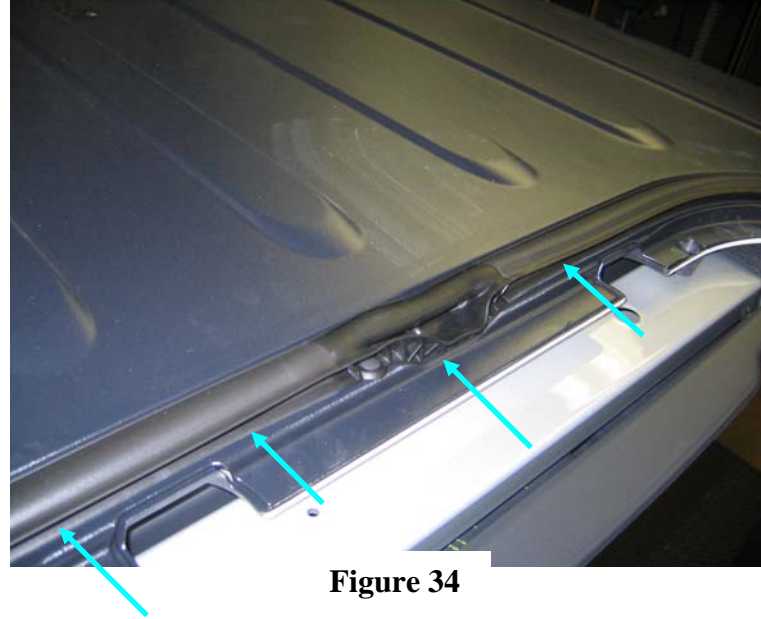

B-Pillar Mocket/Foam Seal Repair

STEP 2: Replace Hard Top Seal

- If there are multiple skips or the leak cannot be stopped, replace seal.
- Remove all tape/butyl and clean with alcohol prior to installation
- A rubber wheel bit can be used to remove the tape
- Pre-apply butyl (68027813AA) on hard top prior to installing the seal (Figure 36)
- It is critical that then end molds are installed correctly and sufficient pressure is applied to wet out the butyl/tape (Figure 36)

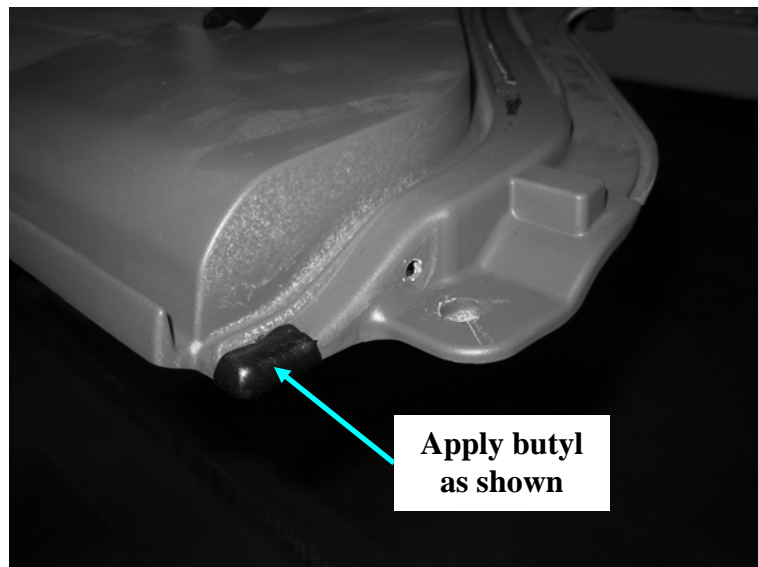

Figure 36

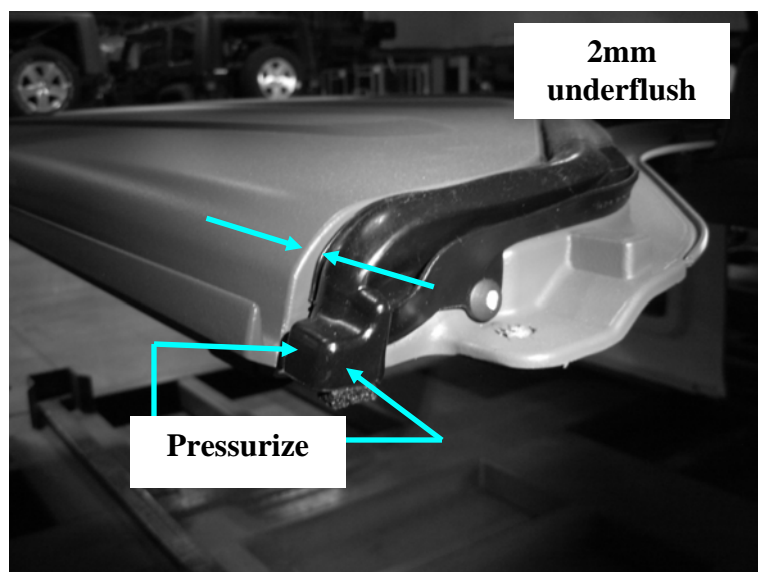

Figure 37

B-Pillar Mocket/Foam Seal Repair

AREA OF LEAK:

- This repair procedure is applicable when water is evident on the:
 - B-plr trim or seat

NOTE: This repair applies to 4 door hard top or soft top models

STEP 1: Inspect mocket detail

- Inspect the mocket for a rolled under condition (Figure 38)
- Inspect the mocket for a missing drain hole

STEP 2: Replace the mocket detail

- If either of these conditions exist, replace the mocket detail (Part #:55395708/9AE)
- Reinstall the panel or side rail making sure not to distort the mocket



Figure 39

B-Pillar Mocket/Foam Seal Repair

STEP 3: Inspect Freedom Panel for damaged or missing foam

- If the foam is damaged or missing, replace the foam using the foam kit (68026937AB)

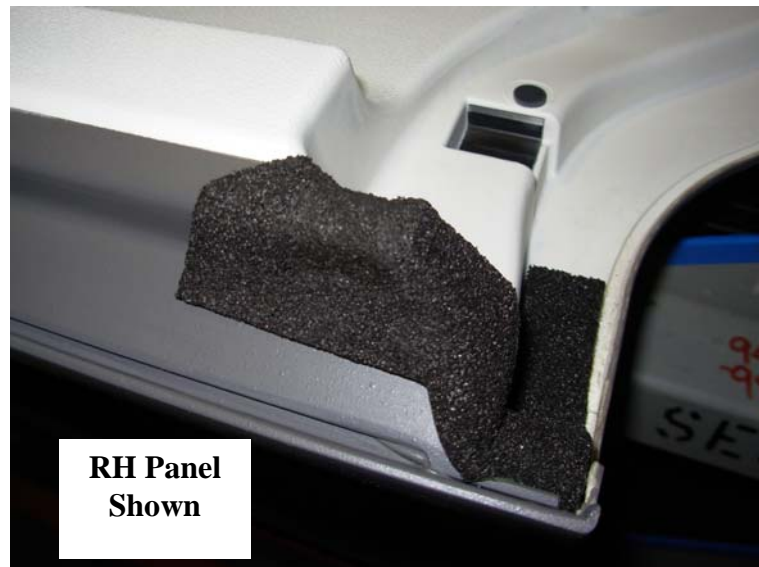

Figure 40

STEP 4: Add additional foam to freedom panel

- Add a piece of foam to the freedom panel as shown in Figure 41. This foam can be created by cutting the 30 x 75mm GREY foam in half from the foam kit (68026937AB)
- Figure 41

NOTE: This foam is in addition to the foam that is already on the panel



Figure 41

Rear Wheel Flare Hole Repair

AREA OF LEAK:

- This repair procedure is applicable when water is evident on the:
 - Front floor (wet carpet)
 - Under seat

NOTE: This leak can be diagnosed by applying a hose to the upper rear flare and inspecting for water traveling along the floor to the front

STEP 1: Remove Rear Flare

STEP 2: Replace/Install Patch

Hole : 1

NOTE: Vehicles built prior to 5/28/08 will require this repair

- Inspect the body for missing or misaligned tape over the hole as seen in Figure 43
- Add/Replace a tape patch over the hole

Hole: 2

NOTE: Vehicles built prior to 5/01/09 will require this repair

- Inspect the body for missing or misaligned tape over the hole as seen in Figure 43
- Add/Replace a tape patch over the hole

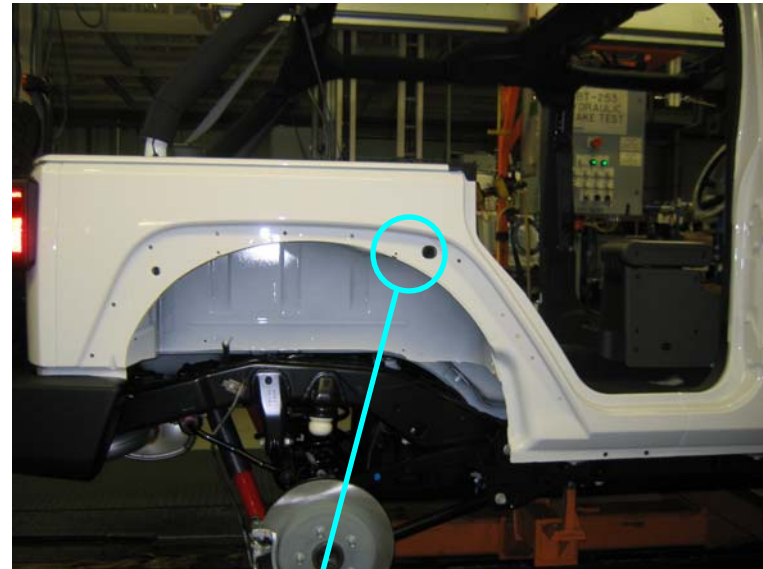

Figure 42

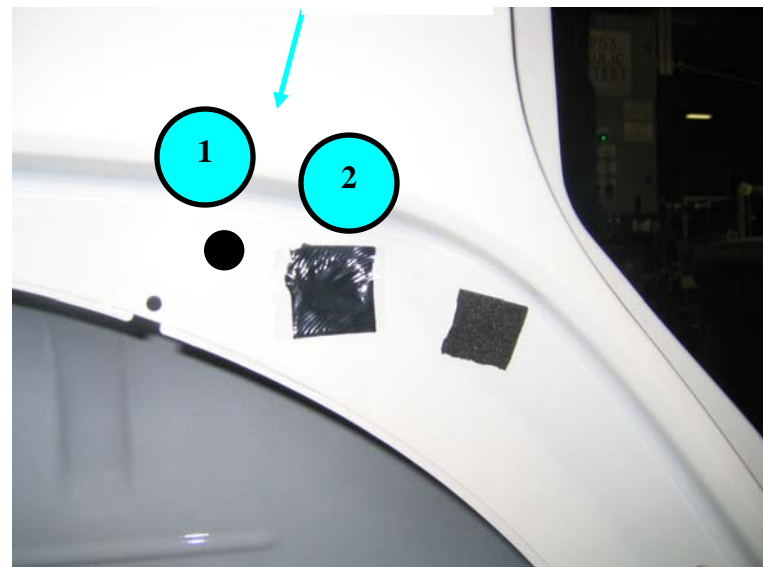

Figure 43

Rear Wheel Flare Hole Repair

Hole:

3

NOTE: Vehicles built prior to 7/22/08 will require this repair

- Cut the BLACK 30 x 75 foam from the foam kit (68026937AB) in half and apply over this hole (Figure 45)
- Make sure the foam does not extend past the flare trim line (appearance issue)
- Re-install flare

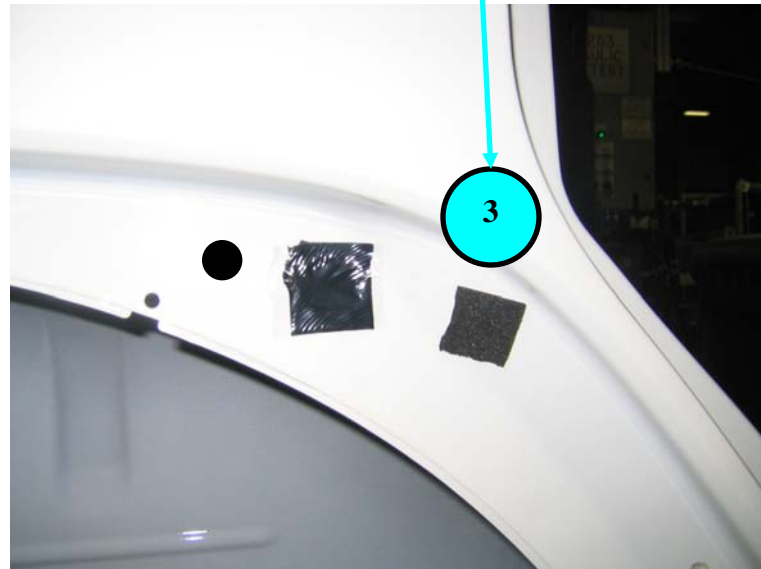
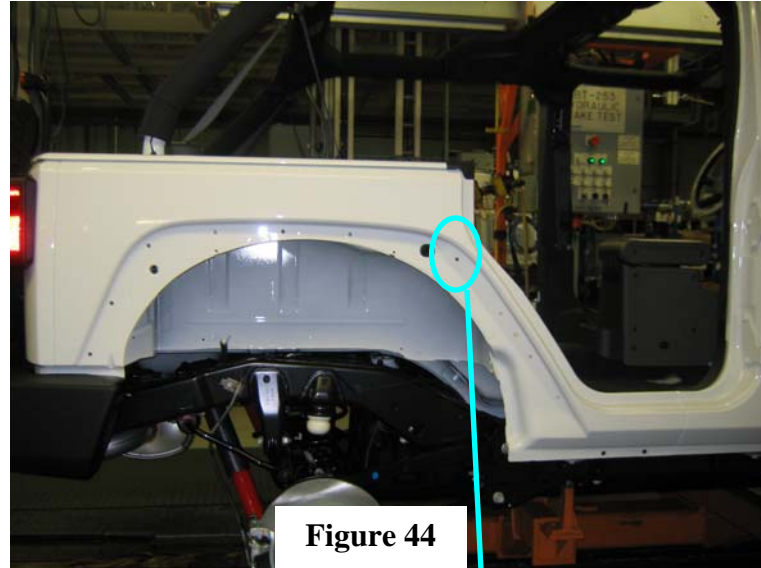

Cowl Side Panel Repair

AREA OF LEAK:

- This repair procedure is applicable when water is evident on the:
 - Front floor (wet carpet)

NOTE: These leaks can be diagnosed by applying a hose in the cowl panel (Figure 47).

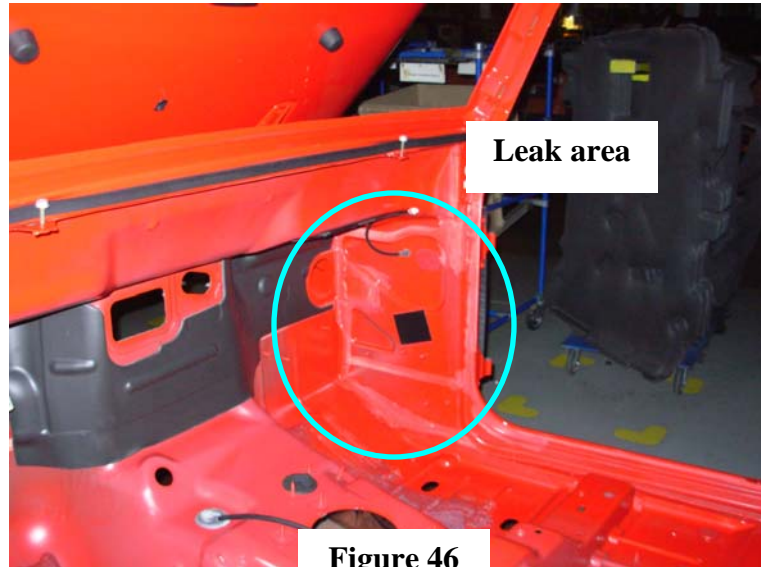

Cowl Side Panel Repair

Condition 1: Mastic patches/Plugs

Repair 1: Replace patch/plug

Condition 2: Check strap bracket

Repair 2: Remove bracket and apply a butyl to holes

Condition 3: Seam sealer skips

Repair 3: Apply clear sealer (part #: 04467708) to skip

Condition 4: Scuff trim foam damaged/missing

Repair 4: Replace trim clips

Condition 5: Antenna grommet not seated

Repair 5: Re-install grommet

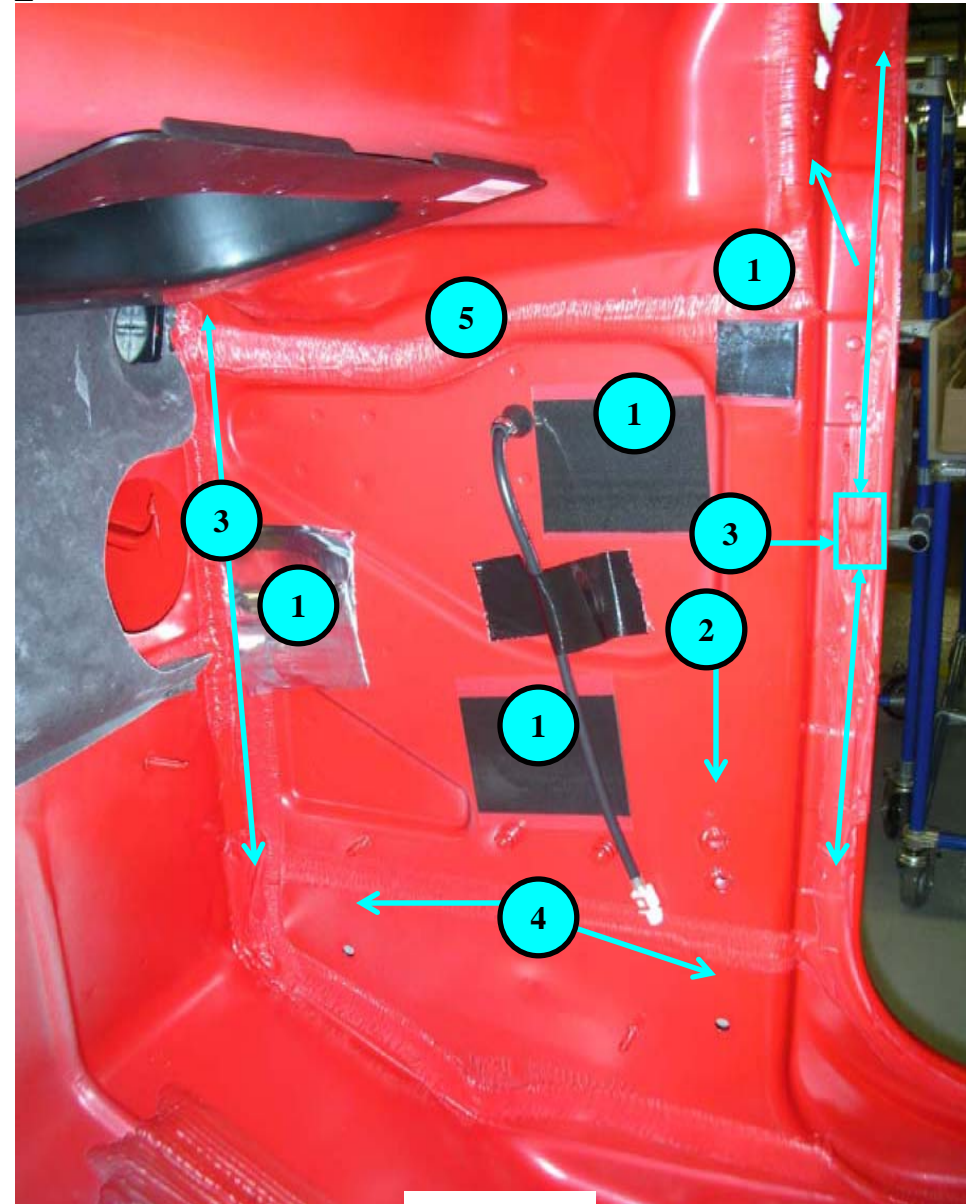

Figure 48

Appendix

Foam Kit: 68026937AB



A/B-Pillar Foam

- Used on Pages (5,16,)

30 mm x 75mm BLACK Foam

- Used on Pages (10,11)

30 mm x 75mm GREY Foam

- Used on Pages (9,16)

Appendix

Jeep Wrangler Replacement Parts List

Part #	Part Name	Page(s)
68027813AA	Butyl	2,7,10,14
04467708	Clear Sealer	20
68026937AB	Foam Kit	5,9-11,16
55397454AE	Windshield Header Seal	2
55395274/5AN	Front Door Primary Seal	3
55395708/9AE	B-Pillar Mocket	15
55397095AG	Freedom Panel Seal	8
55397046AF	Hard Top Seal 4DR	14
55397058AF	Hard Top Seal 2DR	14
68004562AB	Freedom Panel Latch	11

JK Freedom Top -Center Front- Water Leak Repair

Reference TSB # 23-020-08 As Required for additional Repair Information

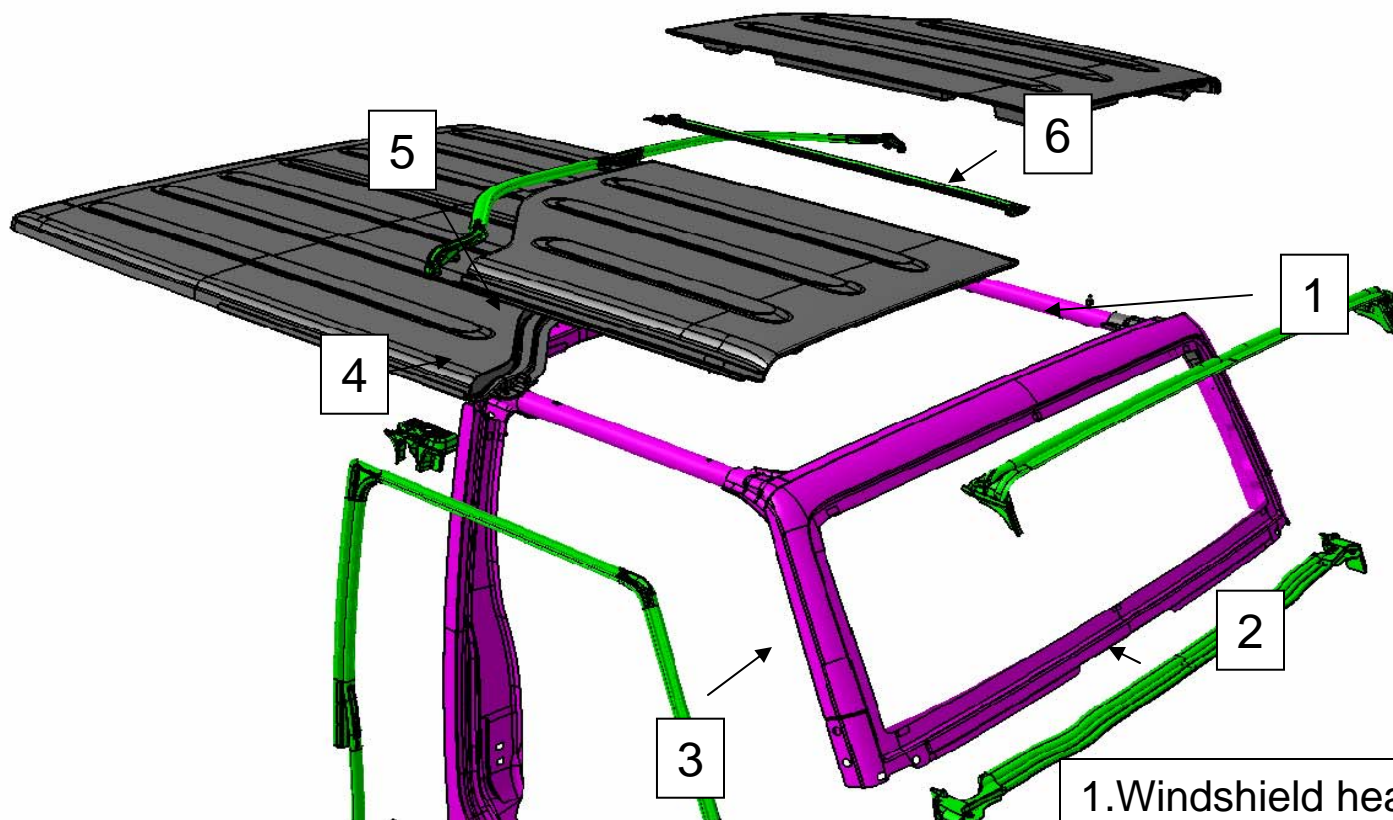
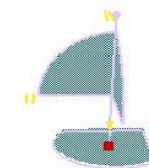

Outside View

- 1. Windshield header seal
- 2. Windshield to cowl seal
- 3. Front door weatherseal
- 4. B pillar mocket
- 5. Hard top seal
- 6. Center freedom panel seal

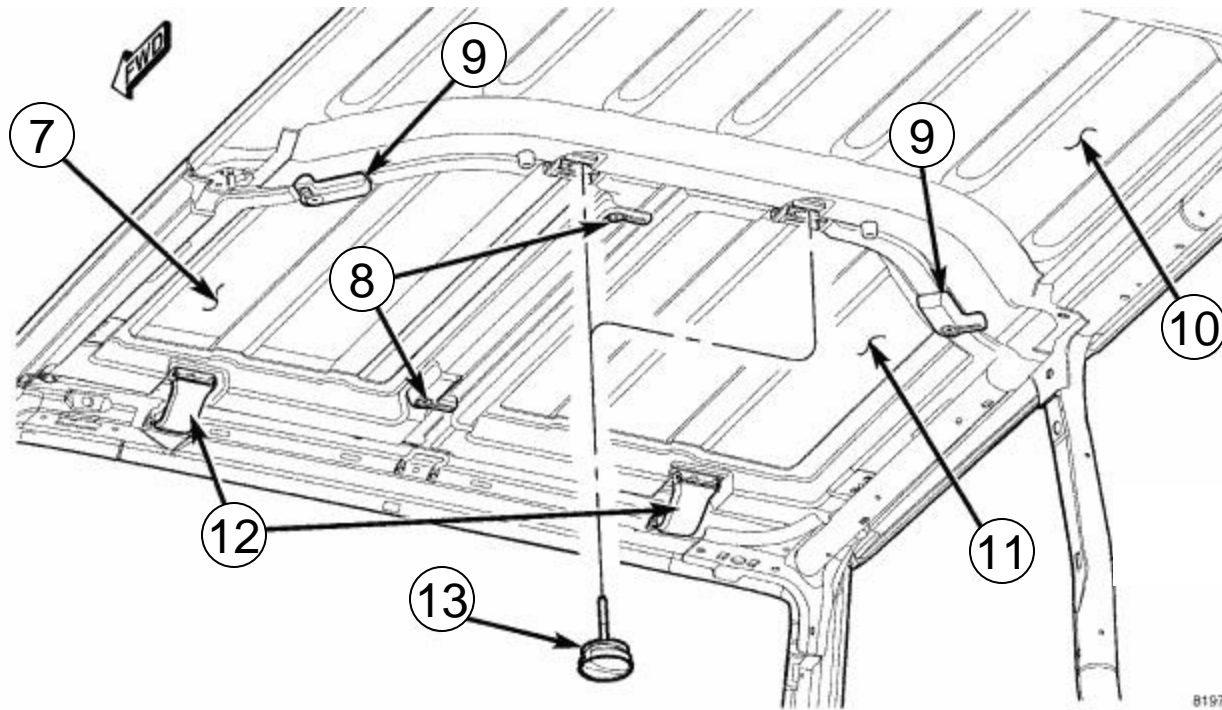

Inside View

- 7. Left Freedom Panel
- 8. Panel to Panel Latches
- 9. Panel to Hard Top Latches
- 10. Hard Top
- 11. Right Freedom Panel
- 12. Latch & Base Assembly 68004562AB
- 13 Sport Bar Thumb Screws

***Please note:**

This package addresses water leaks that come from inside the vehicle when the door is closed.

This package **does not** address water that drips into the Vehicle when the door is open.

This is a normal condition!



Foam Kit Contents

68026937AB

These parts with
Light Blue shaded
boxes are Optional /
Replace as required

30 mm x 95 mm x 3 mm-
thick. 2 pieces.

20 mm x 95 mm x 5 mm-
thick. 2 pieces.

2 Pair.

2 Pair

7mm OD x 71mm. 2 pieces

13mm OD x 8mm ID x 160mm. 1 piece.

9 mm x 100 mm x 6.35 mm-
thick. 2 pieces.

30 mm x 75mm x 3 mm-
thick. 3 pieces. Black
Foam

30 mm x 75mm x 2 mm-
thick 1 piece. Gray Foam

10/14/2008

**These 4 pieces of foam are required
for the freedom panel repair.**

Additional Hard Top Foam Locations Included in the foam kit. Replace as required.



10/14/2008

6

Right Freedom Panel

Weather Strip Removal & Freedom panel Cleaning

Remove Right Freedom Panel Center Seal



10/14/2008

Remove old Butyl & Tape from Right Freedom Panel

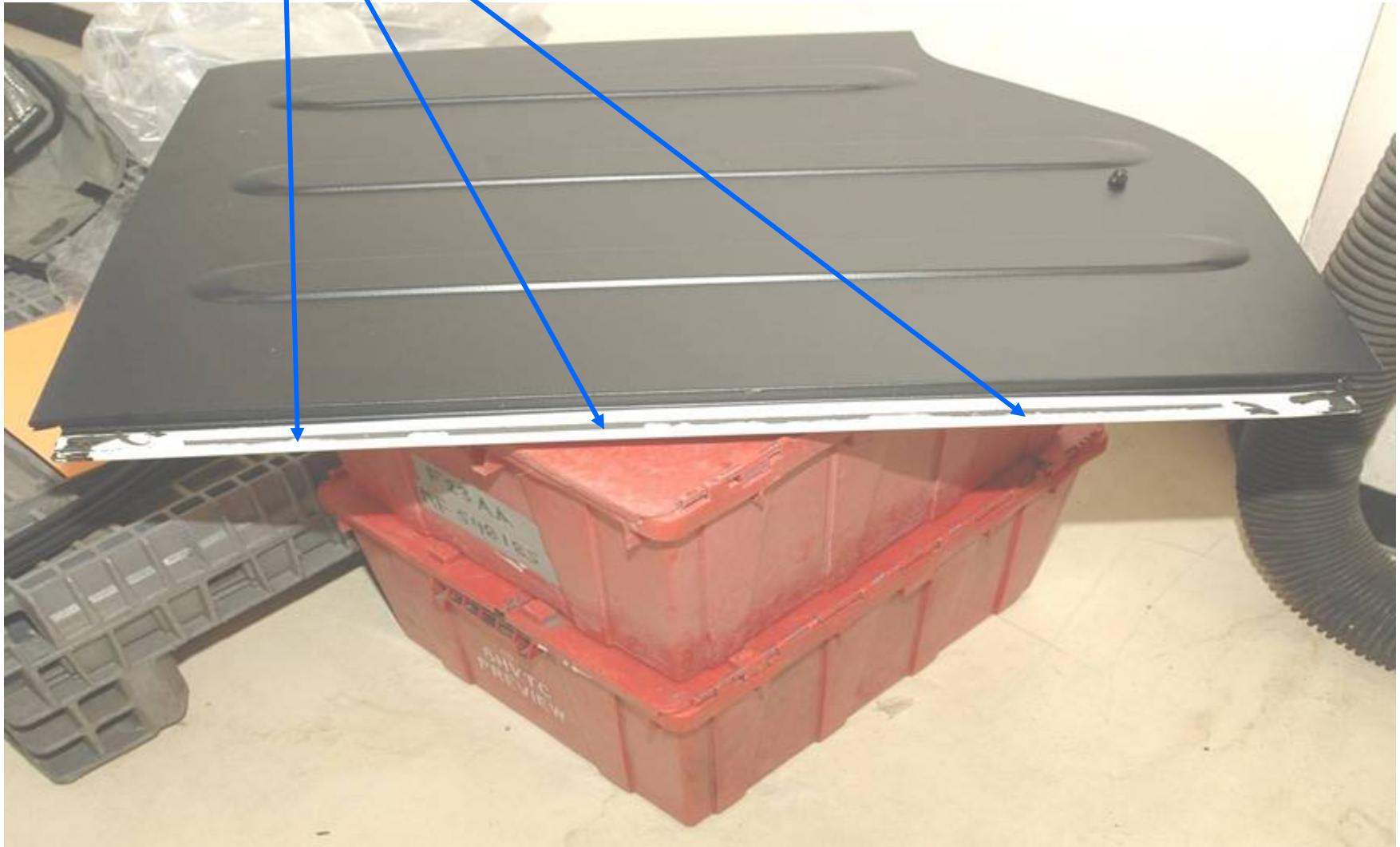

10/14/2008

9

Note: Old Butyl Removed from Right Freedom Panel

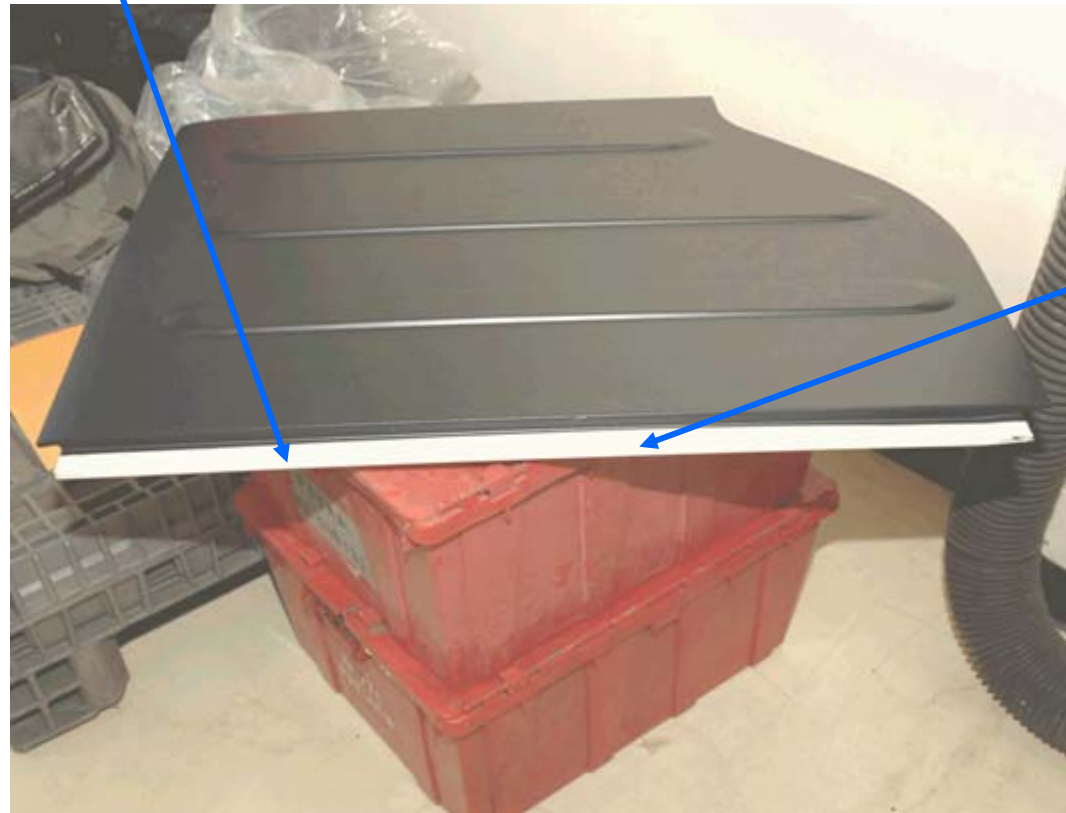

Seal Surface
(White Strip)

Clean Seal Surface with: 3M General Purpose Adhesive Cleaner or Kent Products Acrysol, (if available) and allow to dry completely. Rough up Seal Surface with Medium Scotch Bright pad. Wipe Seal Surface with Alcohol and allow to dry completely.

10/14/2008

10

Note: Old Butyl Removed from Right Freedom Panel, **Front** & **Rear** Notches



10/14/2008

11

Place Right Freedom Panel
Upside down on a covered
work surface to prevent paint
Scratching.

Freedom Panel Notch Butyl installation

Page 15 Rear notch

Page 14 Front notch

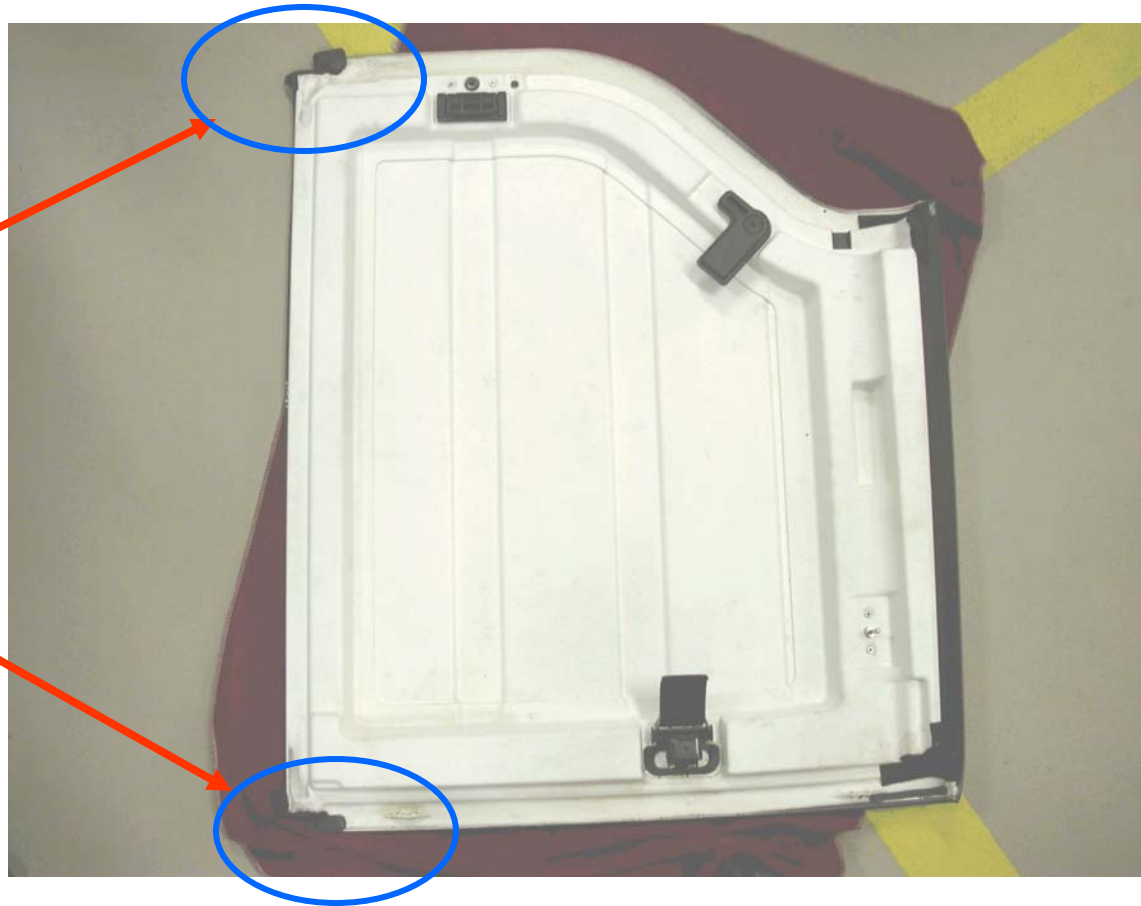

Apply New 4 mm diameter Butyl, Pt # 68027813AA to Right Freedom Panel, **Front** Notch. Note: Follow Groove between panels and Push Butyl firmly in place.

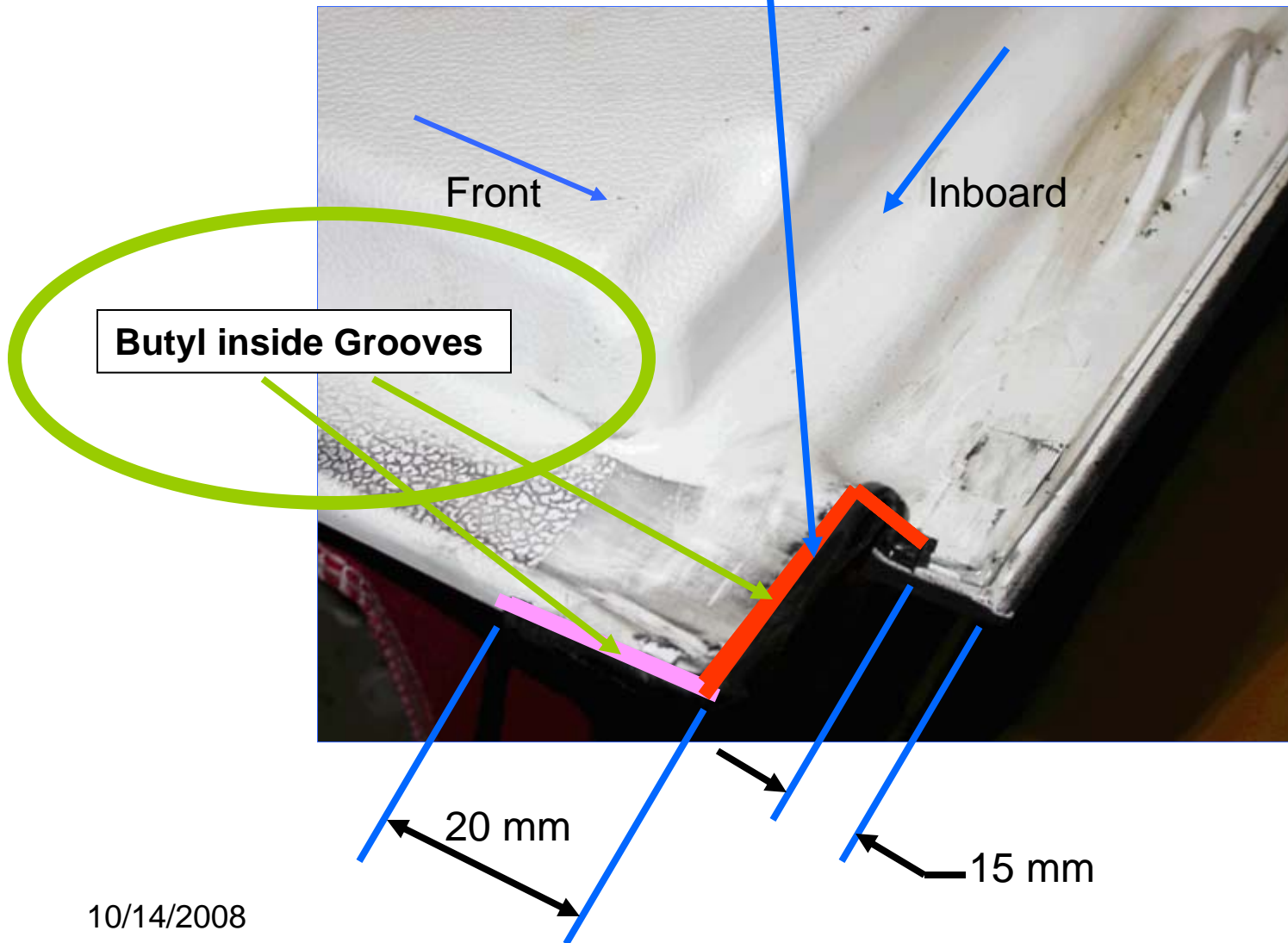

Apply New 4 mm diameter Butyl, Pt # 68027813AA to Right Freedom Panel, Rear Notch. Note: Follow Groove between panels and Push Butyl firmly in place.

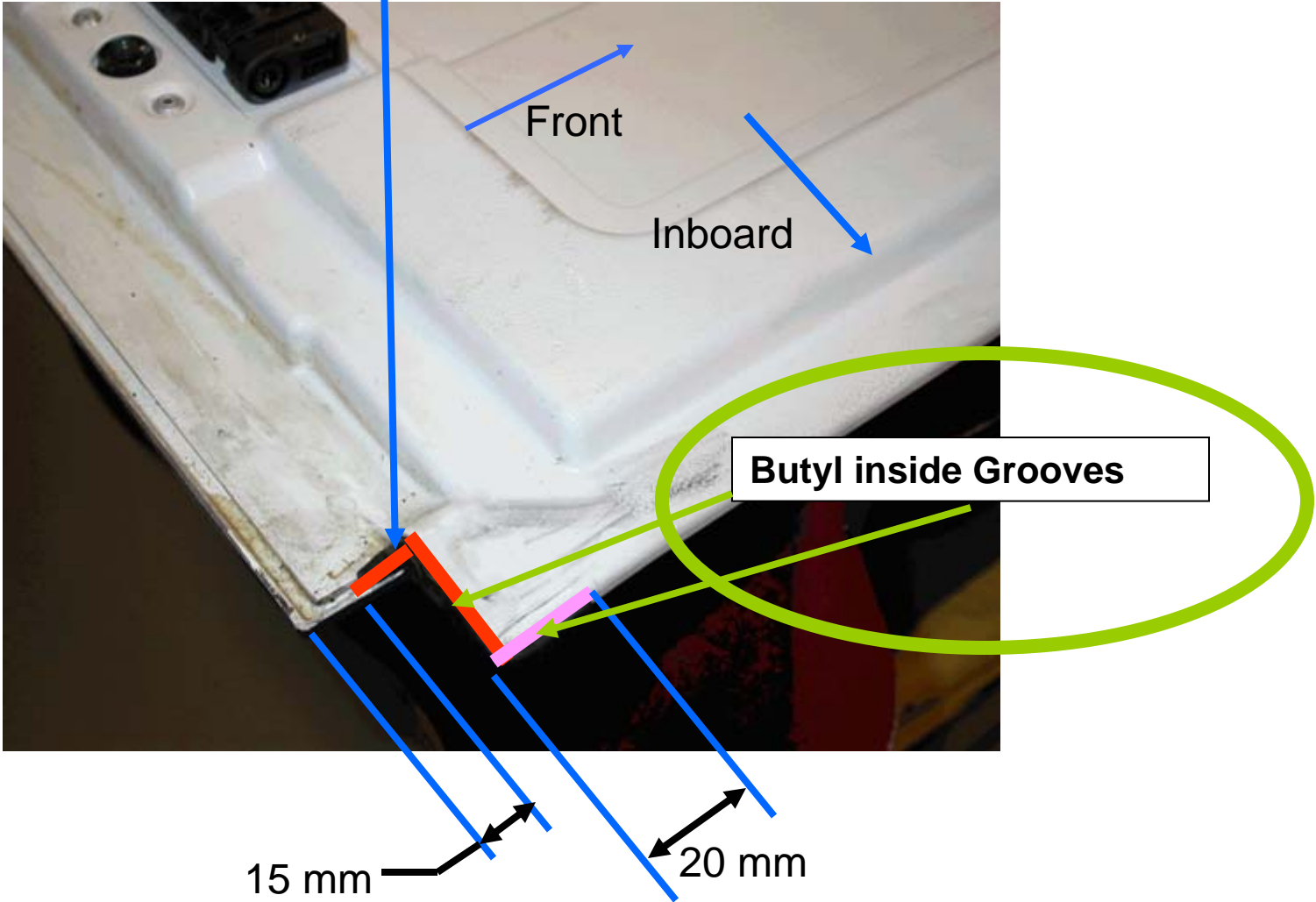

Page 17 Rear Weather Strip

Page 18 Front Weather Strip

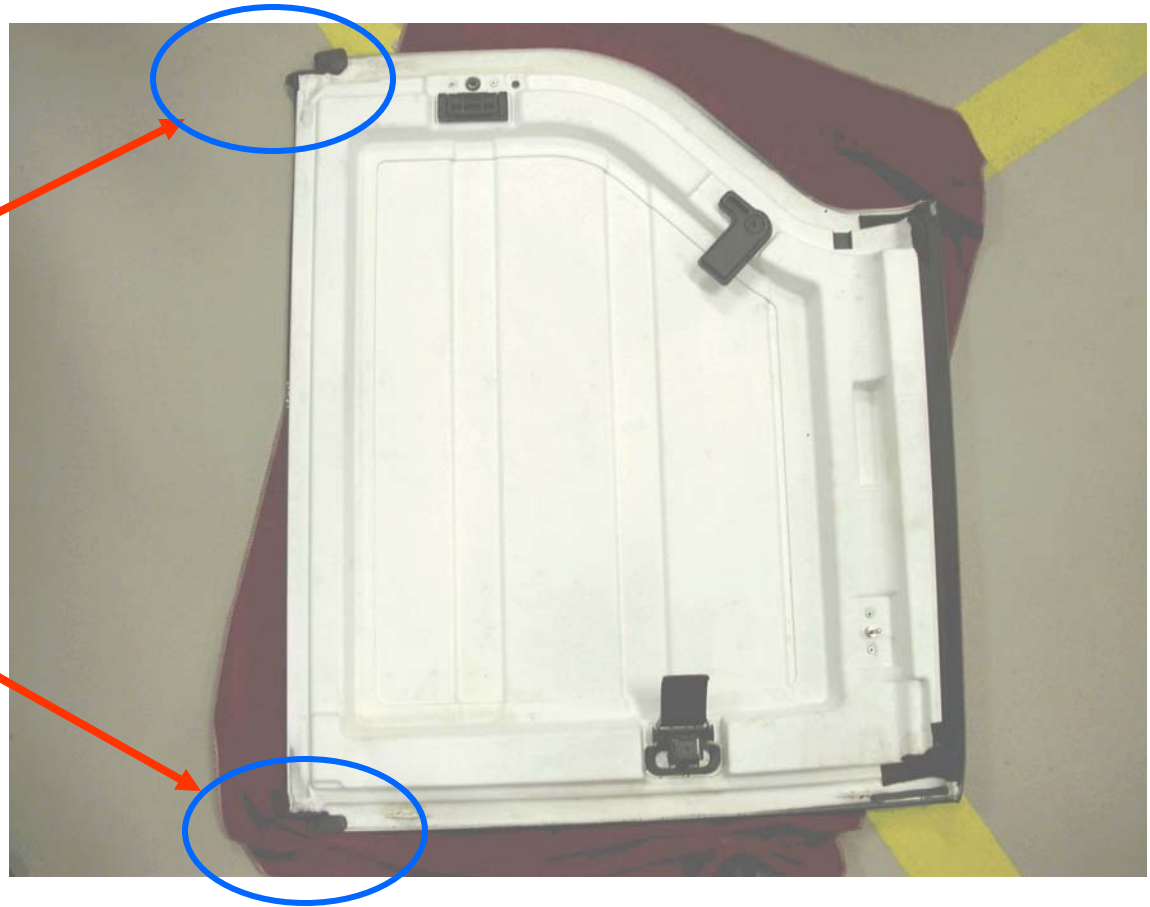

Freedom Panel Weather Strip installation

Align **Rear** edge of NEW Weather Strip, Pt # 55397095AG to Right Freedom Panel Notch. Note: No gap between installed Weather Strip and outer edge of freedom panels.

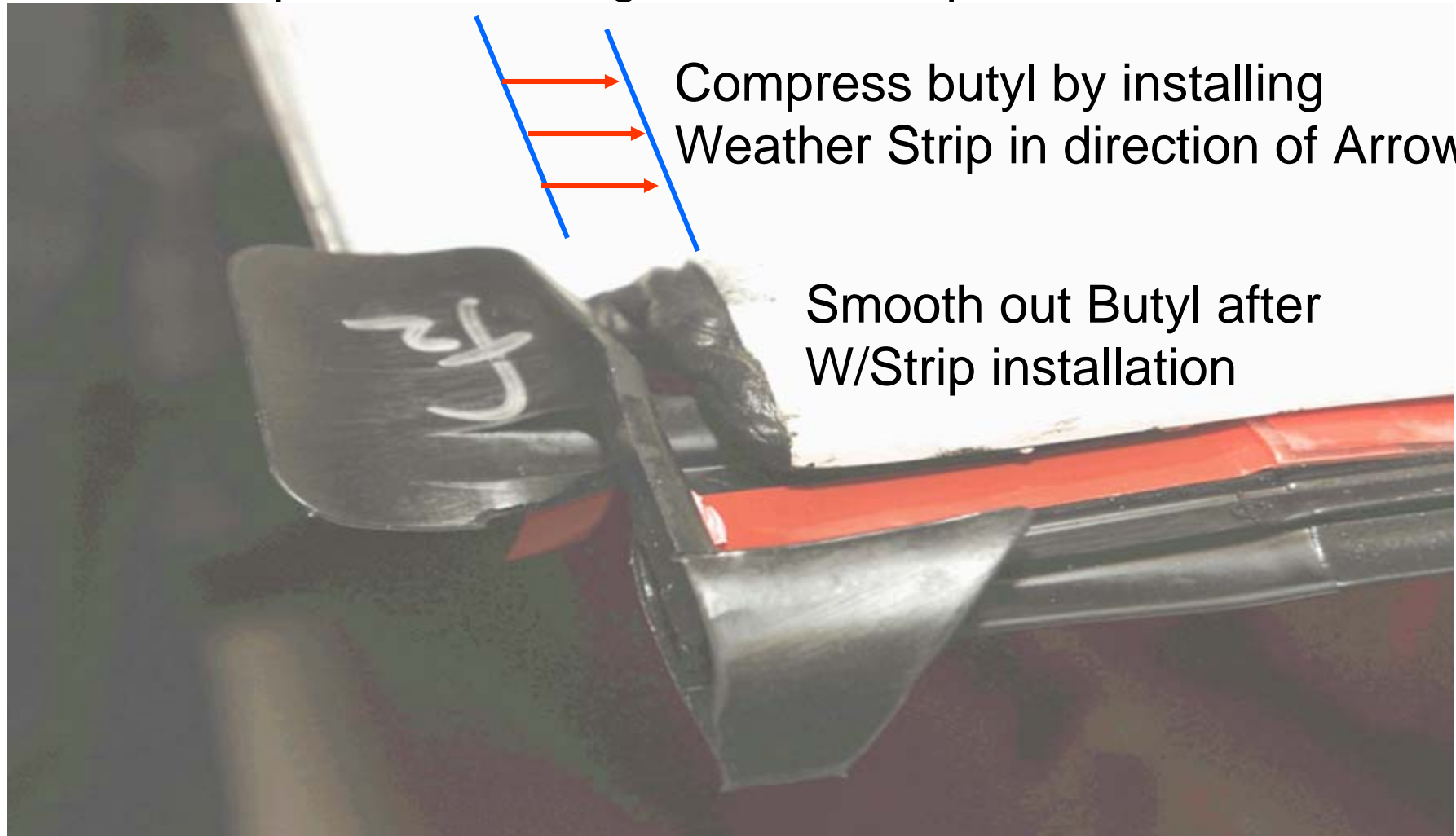

Compress butyl by installing Weather Strip in direction of Arrows

Smooth out Butyl after W/Strip installation

Align **Front** edge of NEW Weather Strip, Pt # 55397095AG to Right Freedom Panel Notch. Note: No gap between installed Weather Strip and outer edge of freedom panels.

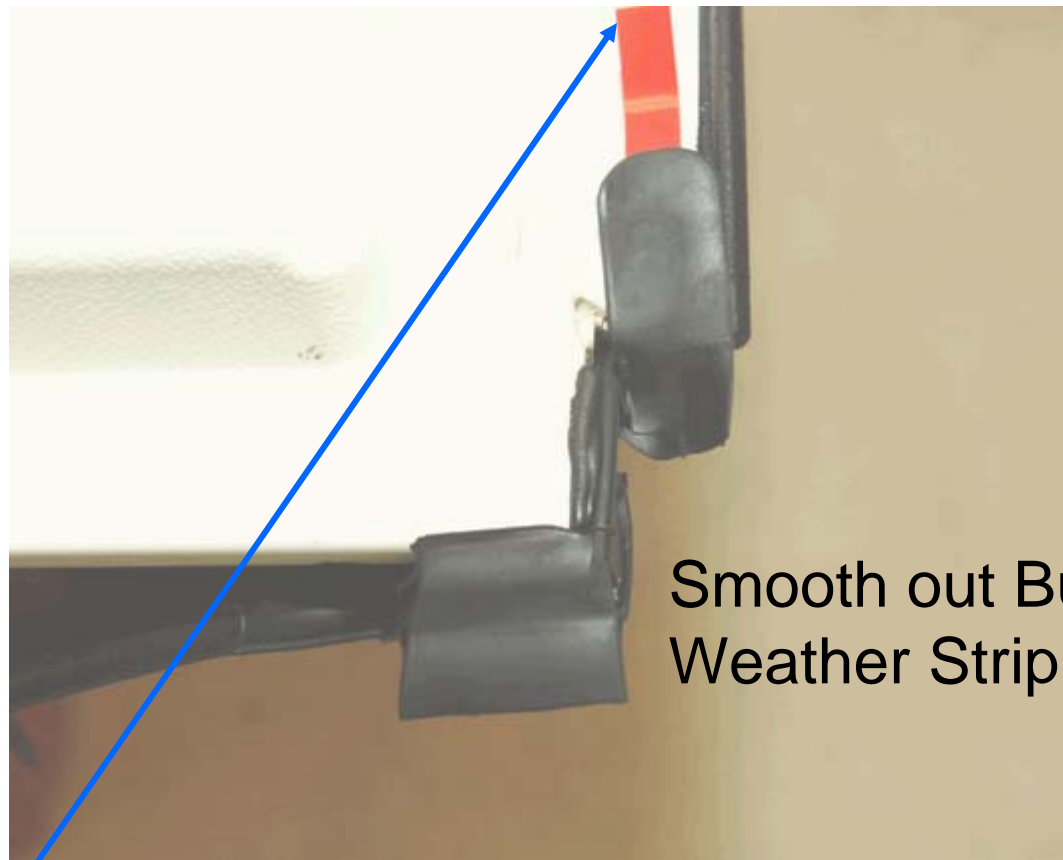

Smooth out Butyl after Weather Strip installation

Note: Remove Release tape and Press Weather Strip Firmly in contact with Freedom Panel, **Front AND Rear** .

Note Both Ends of new W/Strip Located and installed to Freedom Panel Center section still shown unattached



If Vehicle MDH is Before 12/17/07 Replace this Latch on Right & Left Freedom Tops with 68004562AB.



Right Freedom Top Shown

Freedom Panel Latch and Base Assembly
Right and Left

Flip **Right** Freedom Panel
over to complete Weather
Strip installation.

Remove Release Tape, Locate W/Strip cross car against **Rib** in the freedom panel and Pressurize to Freedom Panel **starting at the ends and working toward the center.**

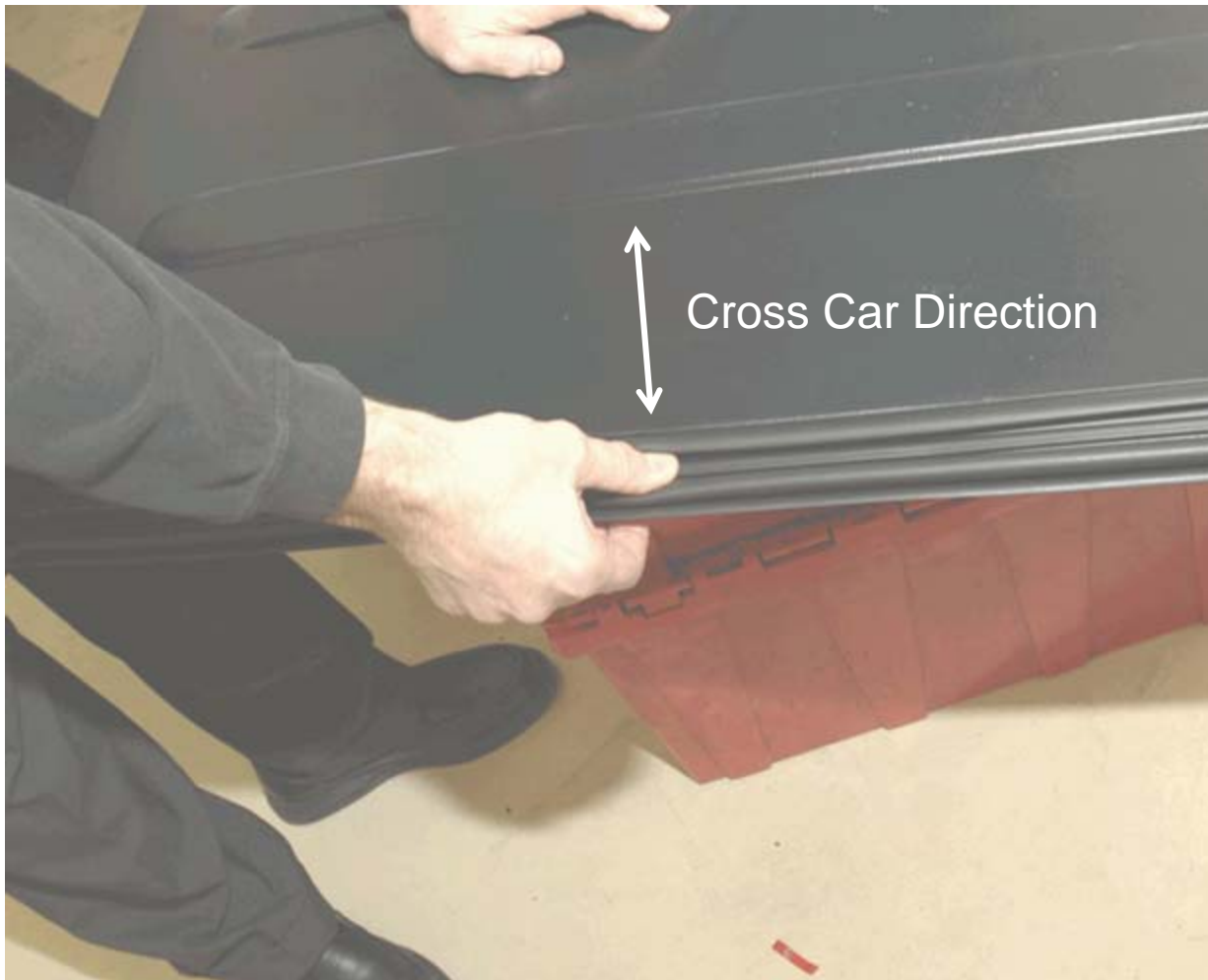

A Small Roller or firm finger pressure should be used to insure the Weather Strip tape is adhered from front to rear,
THIS STEP IS CRITICAL



Top View

Front, page 25

Flame Tips

Rear, page 26

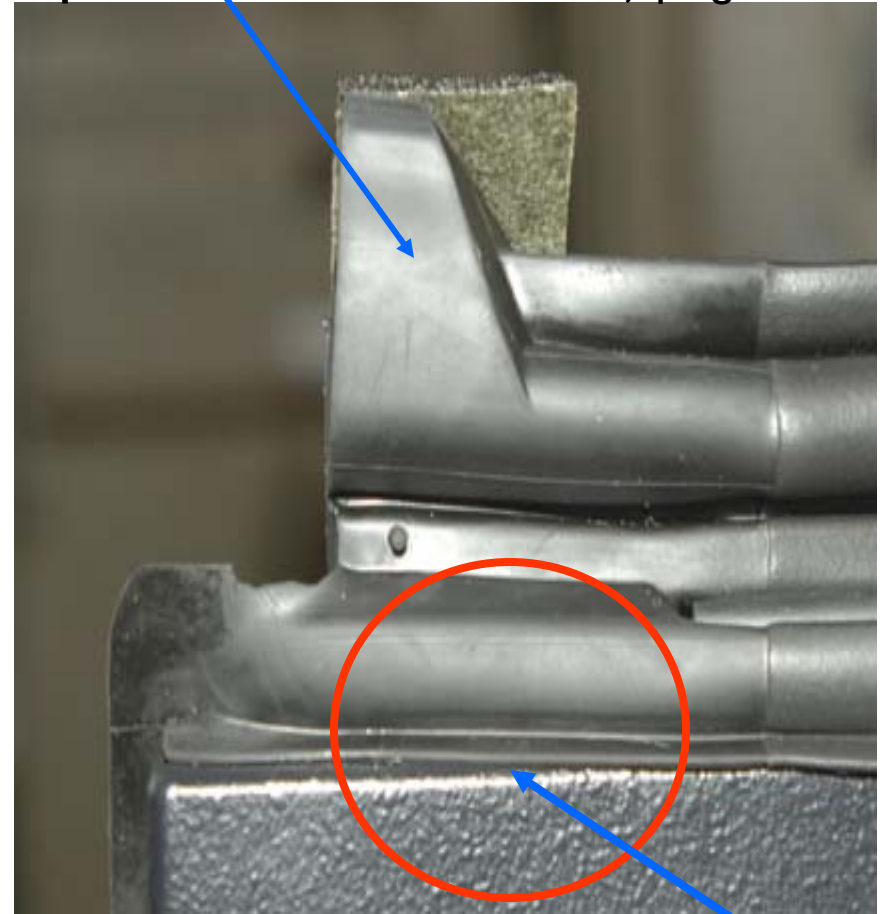

Note: Make sure vertical rubber lip does not roll or get tucked under freedom panel. Correct condition shown is Required at the **Front AND Rear.**

Apply 3M 4298 adhesive promoter on the under side of the flame tip and allow to dry. Align **Gray** 30 X 75 mm Foam from kit along trim lines of Flame Tip.

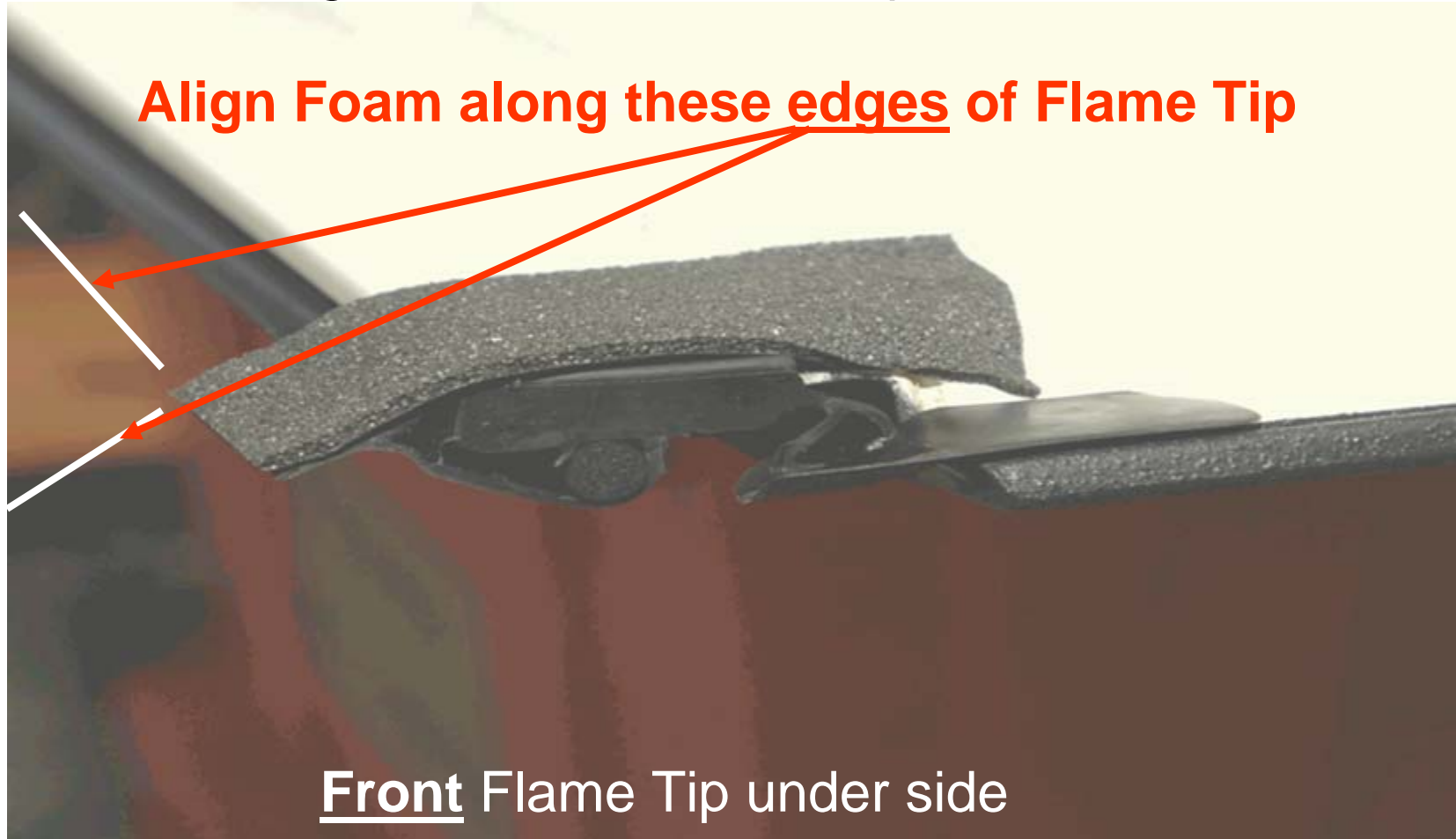

Apply 3M 4298 adhesive promoter on the under side of the flame tip and allow to dry. Align **Black** 30 X 75mm Foam from kit along trim lines of Flame Tip.

Align Foam along these edges of Flame Tip

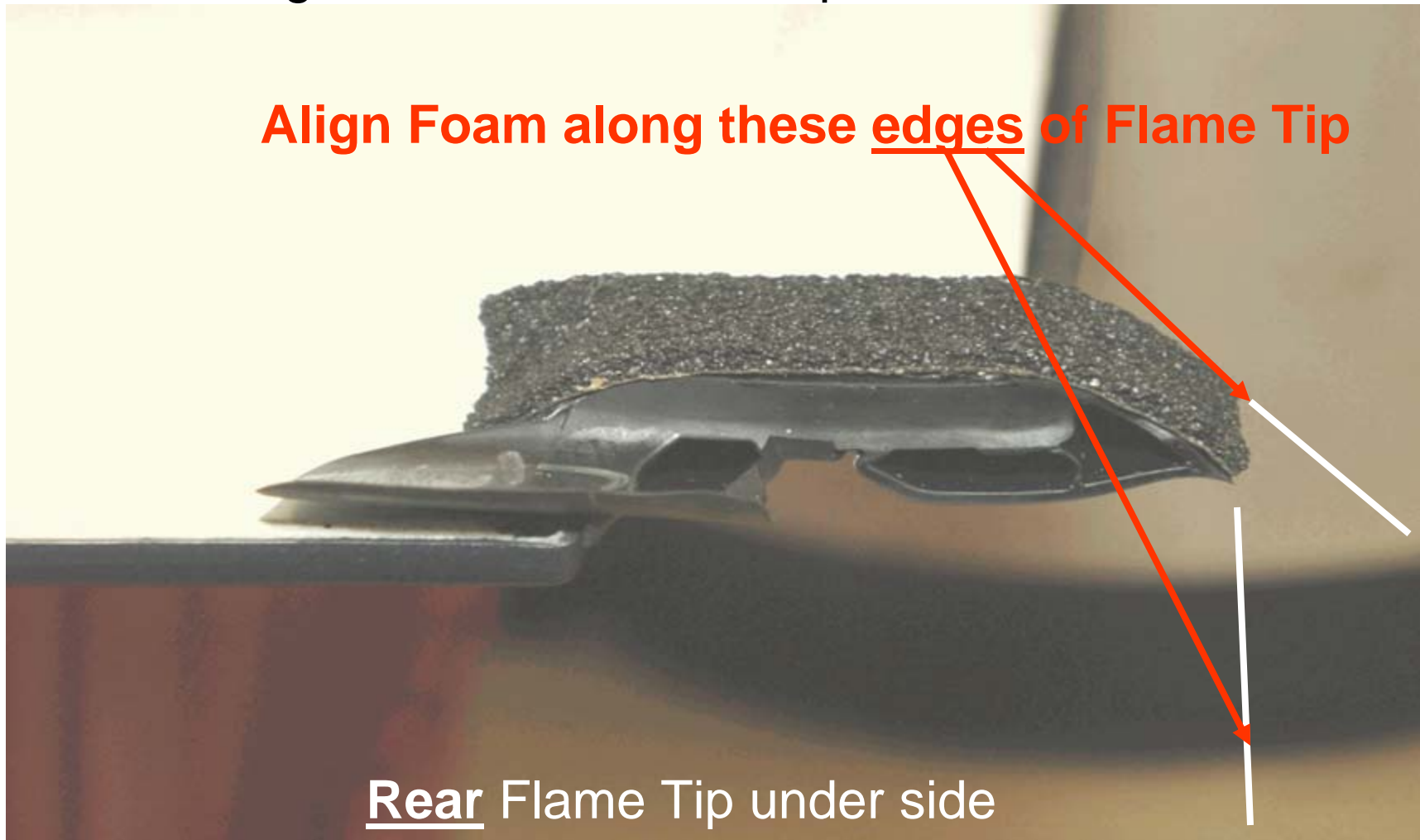

Rear Flame Tip under side

Trim away excess **Black** Foam.

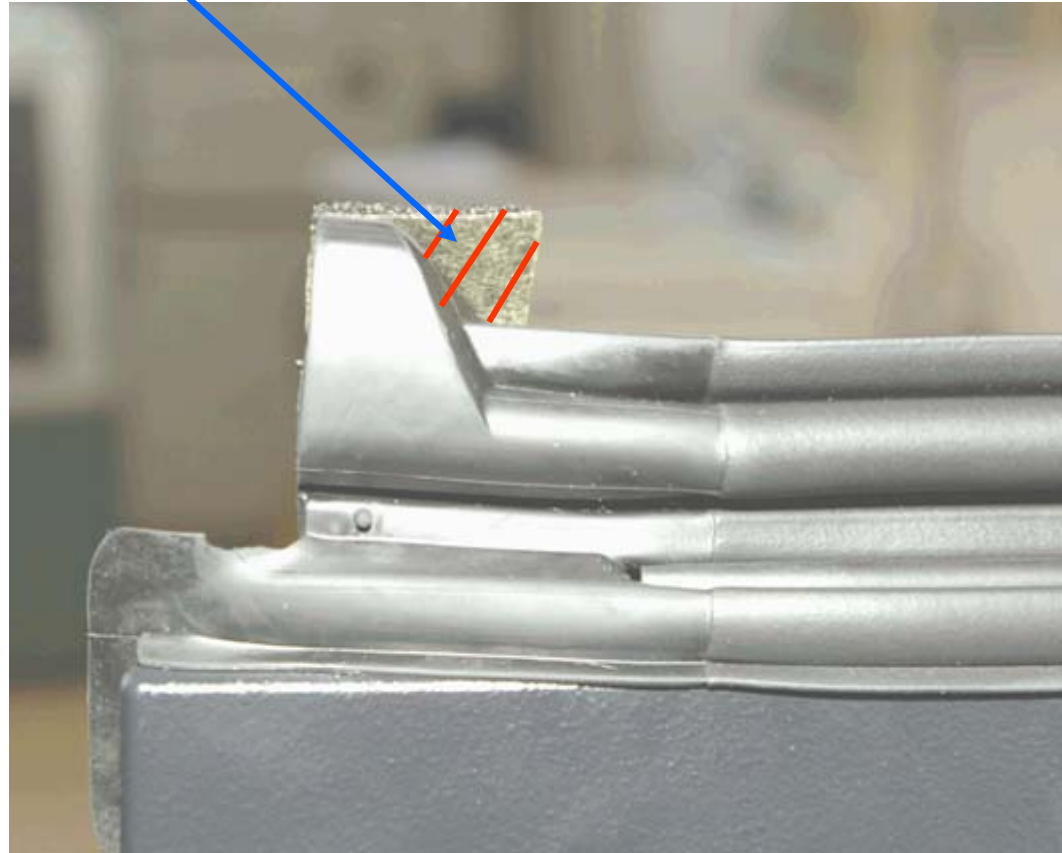

Rear Flame Tip - Top View

Left Freedom Panel

Place Left Freedom Panel Upside down on a covered work surface to prevent paint Scratching

Clean Seal Surface with: 3M General Purpose Adhesive Cleaner or Kent Products Acrysol, (if available) and allow to dry completely. Rough up Seal Surface with Medium Scotch Bright pad. Wipe Seal Surface with Alcohol and allow to dry completely

Rear Inboard Corner Butyl & Foam installation

Add 4mm diameter **Butyl**, Pt # 68027813AA to Rear Inboard Corner groove, Left Freedom Panel

Note: Push Butyl Firmly into groove between panels **until Flush**

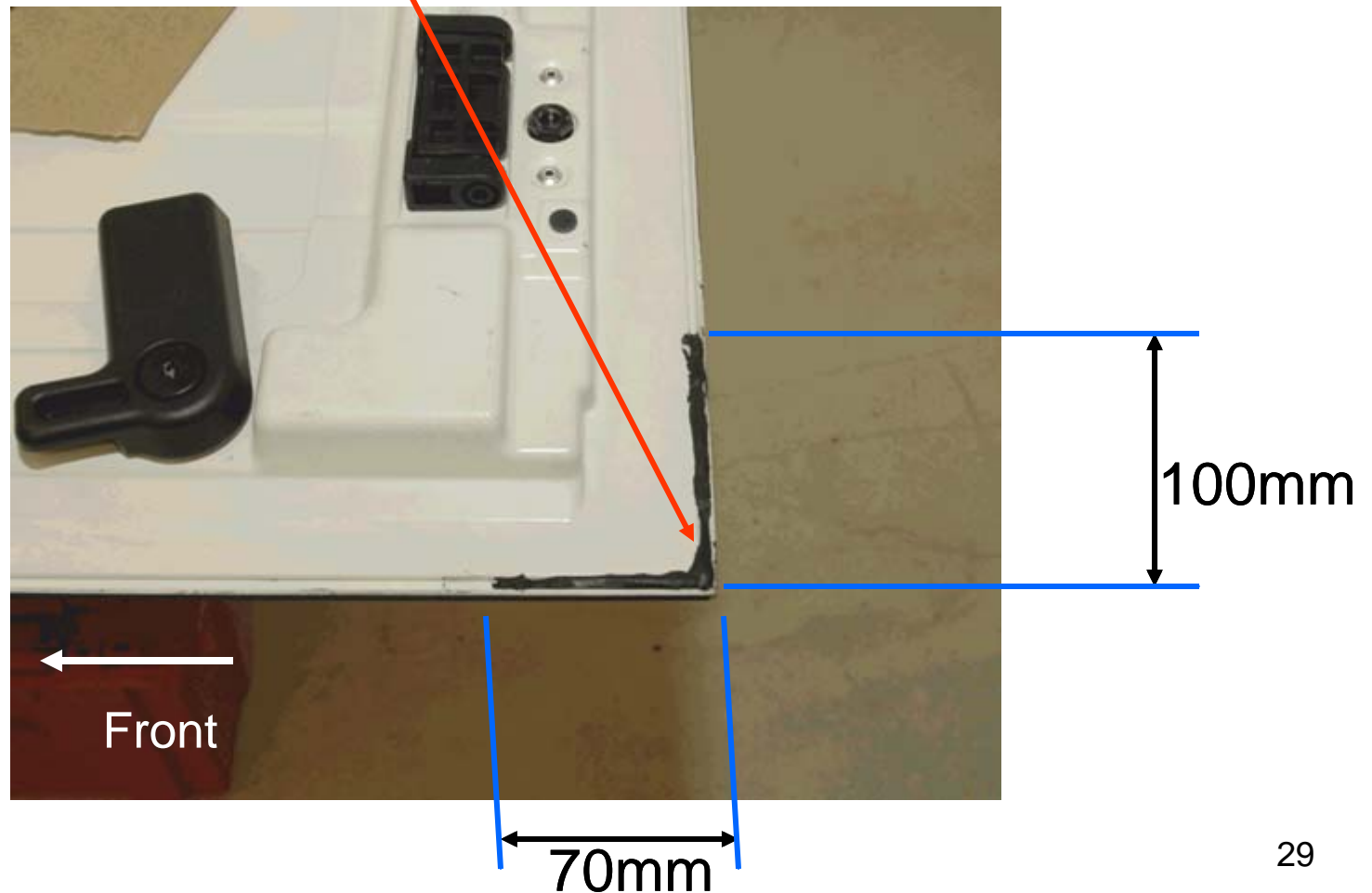

10/14/2008

29

Add 30 X 75 mm **Black** Foam from Kit to cover butyl



Add 30 X 75 mm **Black** Foam from Kit to cover butyl.

Note Make sure Foam covers Butyl.

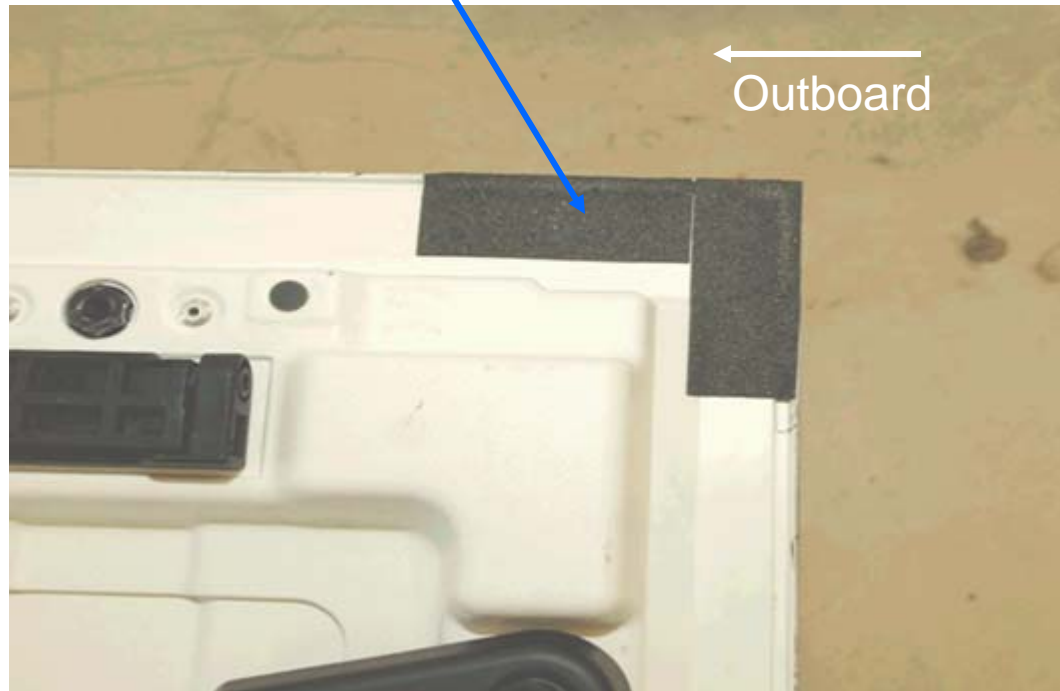

Note: **REMINDER** Refer to Page 20 If Vehicle **MDH** is **Before 12/17/07** . Replace Latch on **Right & Left** Freedom Top with 68004562AB.

Left Freedom Panel complete.

JK “A” Pillar- Header Weather Strip Water Leak Repair

Reference TSB # 23-025-08 As Required for additional Repair Information

***Please note:**

This package addresses water leaks that come from inside the vehicle when the door is closed.

This package **does not** address water that drips into the Vehicle when the door is open.

This is a normal condition!



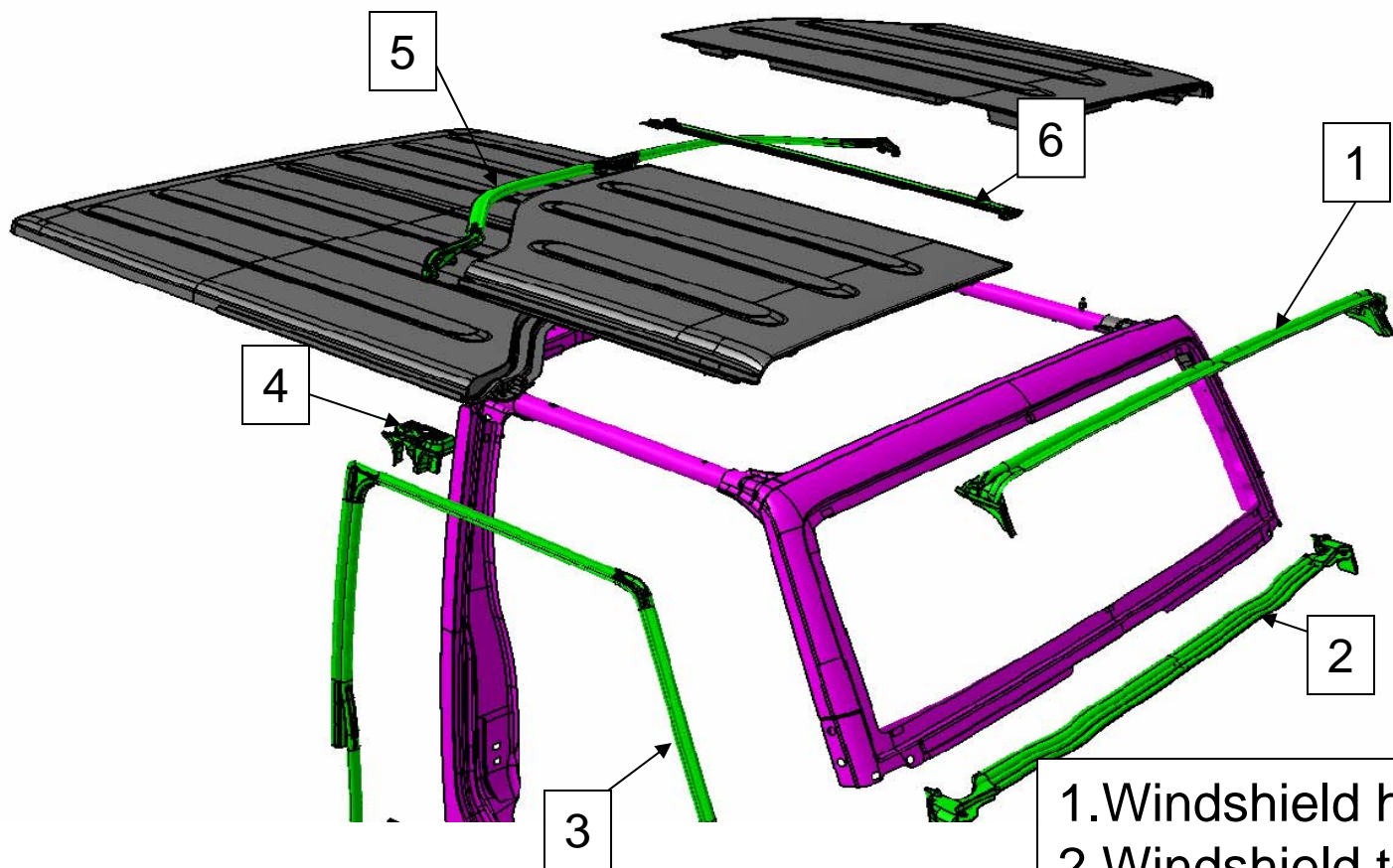
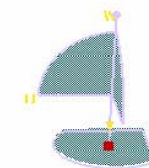

Outside View

- 1. Windshield header seal
- 2. Windshield to cowl seal
- 3. Front door weatherseal
- 4. B pillar mocket
- 5. Hard top seal
- 6. Center freedom panel seal

Check door fit

- The door gap spec. is 5 +/-1.5 mm

Door Must be Flush to slightly under flush to A- Pillar



**Adjust door Gap AND Flushness as described in
Body Section 23 of the Service Manual**

Header Weather Strip

Remove Header Weather Strip from Body sheet metal and clean up / remove all traces of old Tape and Butyl from painted sheet metal surfaces before reinstallation of butyl bead and new weather strip.

Clean Seal Surface with: 3M General Purpose Adhesive Cleaner or Kent Products Acrysol, (if available) and allow to dry completely.

Weather Strip Removal & Butyl Clean Up

Weather Strip Removal & Butyl Clean Up



Clean up / remove all traces of old Tape and Butyl from painted sheet metal surfaces.

Alcohol wipe the clean sheet metal before installation of butyl bead and new weather strip.

Header Weather Strip

Butyl Placement and New Weather Strip Installation.

Right Side Shown on Pages 8, 9, & 10.

Left Side Not Shown but symmetrical / identical to Right

Fill in Gaps between Sheet Metal, Wrinkles, Holes and Notches in this area with butyl until smooth.

3 mm x 3 mm butyl pad as located ABOVE TAPE and on mold line see page 11

Note: Vehicles built after 6/1/2008 MDH have this area filled in with seam sealer from assembly plant.

Note:

Butyl bead **MUST** be completely covered by the header seal mocket in this area.

Be careful DO NOT allow squeeze out, outside of installed mocket!

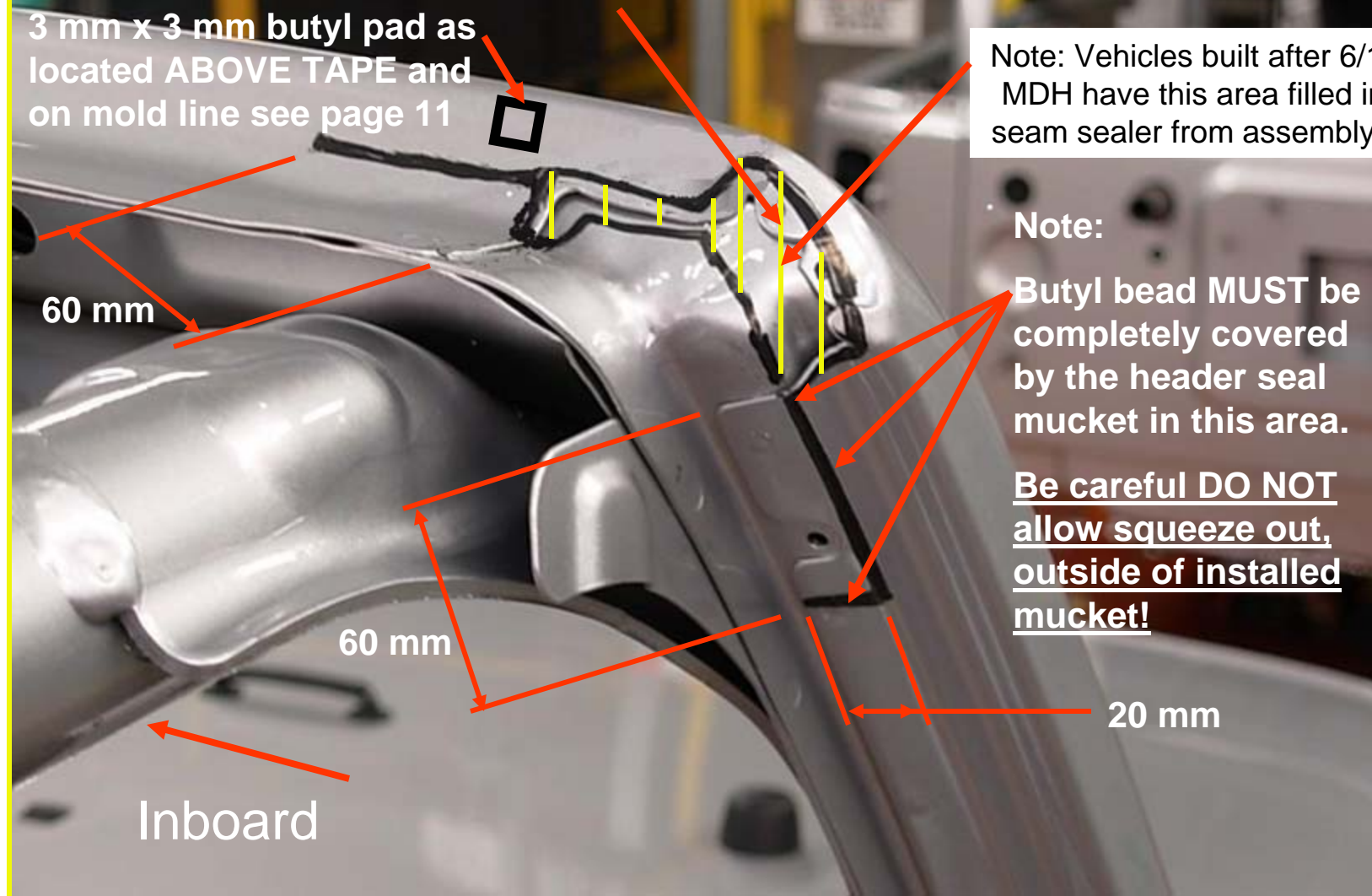

Note: Green dots Show the area where the header weather Strip Adhesive Tape is to be located

**4 mm diameter bead 68027813AA
Replacement Butyl Position. See page 9 for Butyl Dimensions**

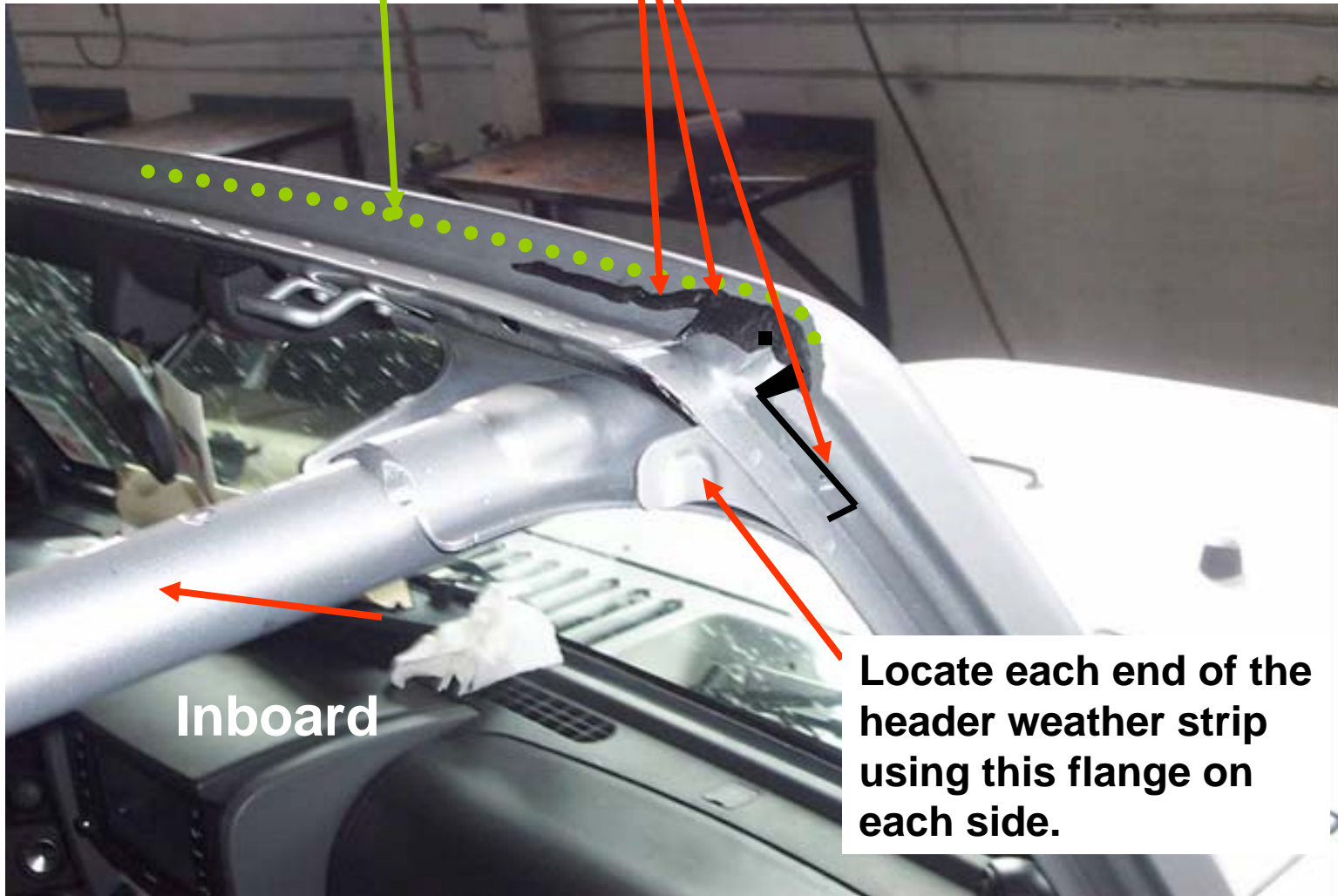

Inboard

Locate each end of the header weather strip using this flange on each side.

Right Side A-pillar

Locate and install NEW Weather Strip, Pt # Strip 55397454AB.

Remove Release tape and Pressurize Weather Strip Firmly in contact with Header Sheet Metal to smooth out adhesive tape and butyl, starting at the ends and working toward the center. A small Roller or firm finger pressure should be used to insure the Weather Strip tape is adhered completely from side to side, **THIS STEP IS CRITICAL**

Gently pull weather strip rearward at mold line shown on page 9 and insert a 3 mm x 3 mm square piece of butyl .

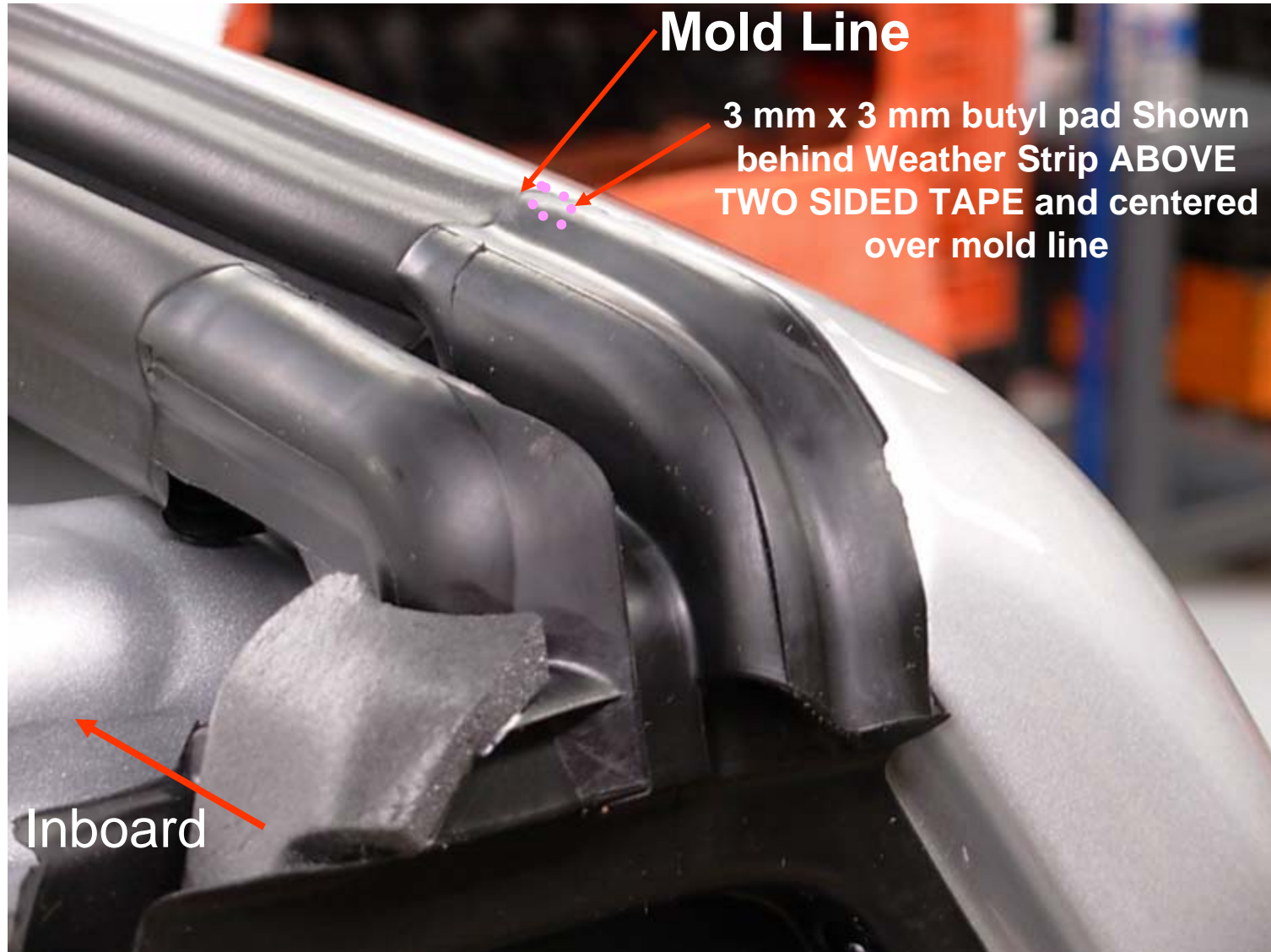

**Right Side A-pillar
Header Seal Installed**

JK -B Pillar- Water Leak Repair

***Please note:**

This package addresses water leaks that come from inside the vehicle when the door is closed.

This package **does not** address water that drips into the Vehicle when the door is open.

This is a normal condition!



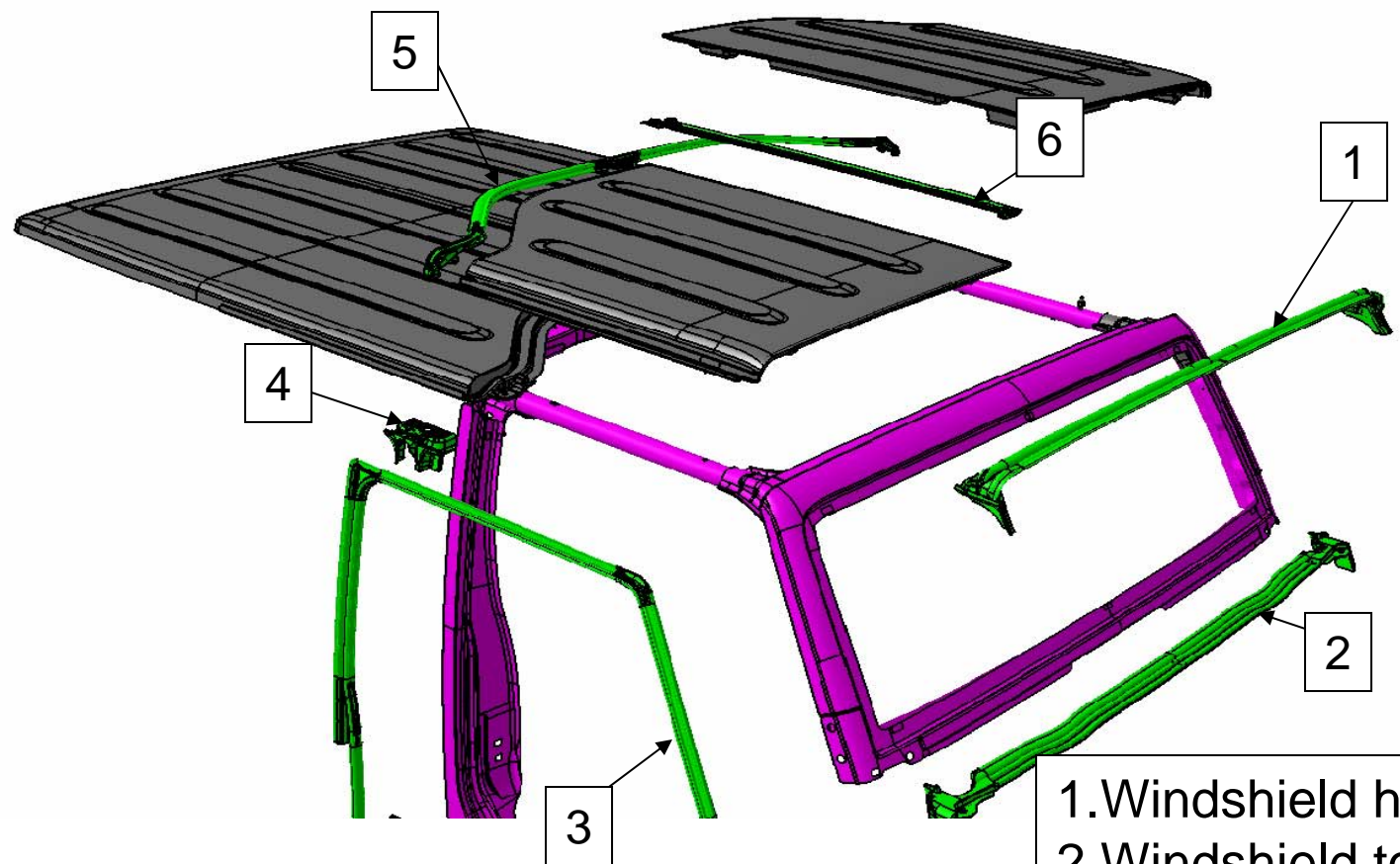
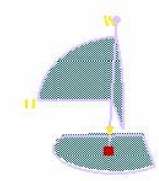

Outside View

- 1. Windshield header seal
- 2. Windshield to cowl seal
- 3. Front door weatherseal
- 4. B pillar mocket
- 5. Hard top seal
- 6. Center freedom panel seal

Note Seal Shown with sealer skips allows water behind seal. This requires the need for additional Butyl to be placed to fill in these voids



W/Strip Repair -Try this step Prior to Replacement

Hard Top Seal at Center

Note Seal Shown gapping to roof allows water behind seal. **This requires the seal to be replaced**

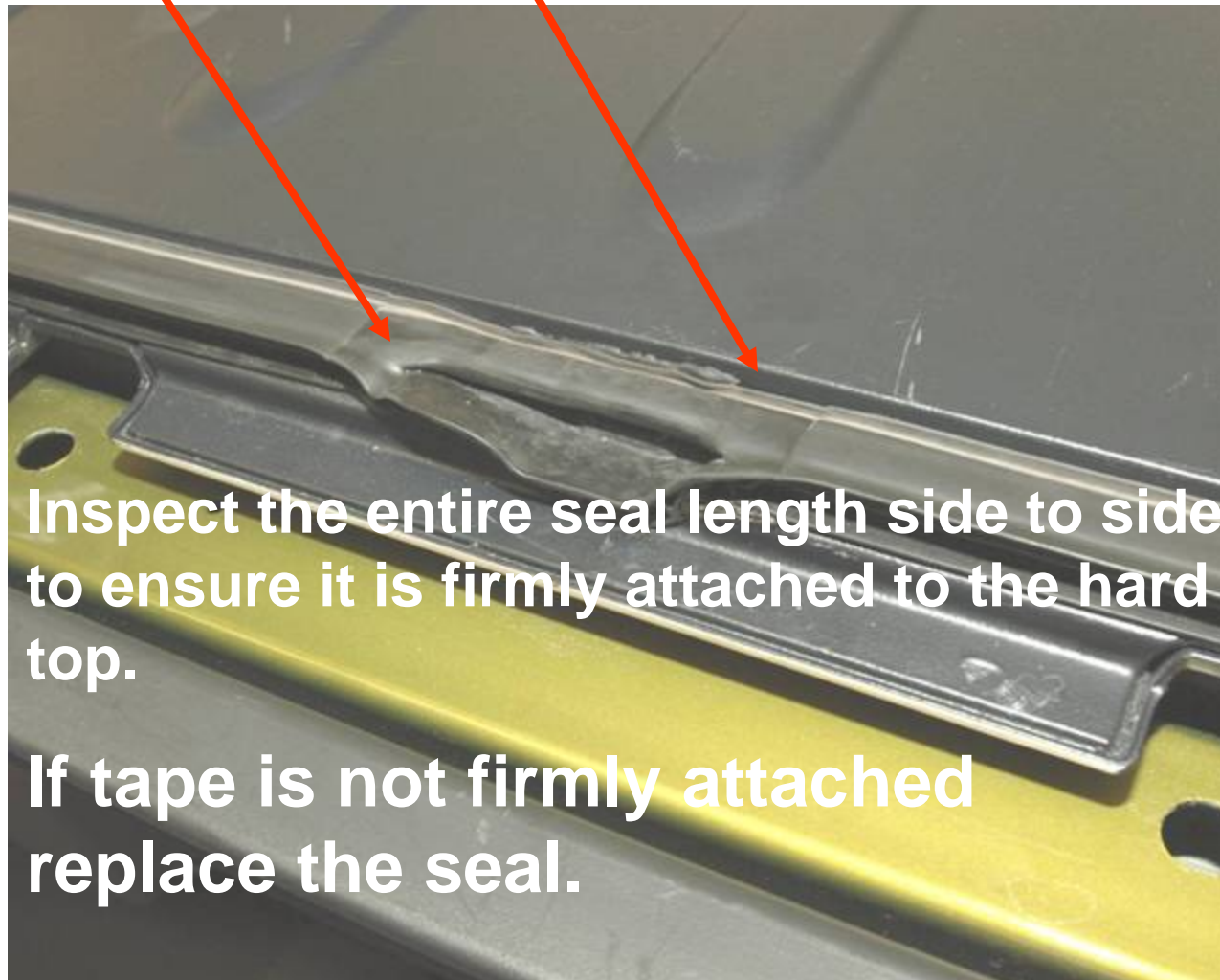

Hard Top Weather Strip

Remove Hard Top Weather Strip from Hard Top and clean up / remove all traces of old Tape and Butyl from painted surfaces before reinstallation of new weather strip.

Clean Seal Surface with: 3M General Purpose Adhesive Cleaner or Kent Products Acrysol, (if available) and allow to dry completely.

Weather Strip Removal & Butyl Clean Up

Hard Top Weather Strip

Alcohol wipe the clean painted surfaces, And Allow Alcohol to dry completely before insallation of new weather strip.

Locate & install NEW Weather Strip, **Pt # 55397058AI (2 DR) or 55397046AF (4 DR)**. Place seal tight against roof / without gaps as shown on page 5. Remove Release tape & Pressurize Weather Strip Firmly in contact with Roof to smooth out adhesive tape, Make sure adhesive tape is **FIRMLY PRESSURIZED** against the roof panel while maintaining a zero gap condition from side to side. A small Roller or firm finger pressure should be used to insure the Weather Strip tape is adhered completely side to side, **THIS STEP IS CRITICAL**

B- Pillar Weather Strip

Remove B - Pillar Mucket Weather Strip from body and clean up / remove all traces of old Tape and Butyl from painted surfaces before reinstallation of butyl bead and new weather strip. Clean Seal Surface with: 3M General Purpose Adhesive Cleaner or Kent Products Acrysol, (if available) and allow to dry completely.

PAGE / S 9 & 11 Show the RIGHT SIDE B-PILLAR & PAGE 12 SHOWS THE LEFT SIDE, THESE REWORKS MUST BE DONE ON BOTH SIDES OF THE TRUCK

Mucket Removal, Clean Up, Butyl & Mucket install and Mucket drain hole and Dam rework

Add a 4 mm diameter bead of Butyl 68027813AA as shown to fill in sheet metal gaps.



Top of Right B – Pillar With Mocket Seal removed

9/4/2008

B- Pillar Weather Strip

Vehicles built After July 1, 2008 will have the drain hole & foam already installed.

The steps on the next page show how to add the drain hole & foam dam.

If B-Pillar weather strip needs to be replaced order the following part numbers:

55395708AC – RT Side

55395709AC – LT Side

Note Single hole paper punch used to add Drain Hole



**Hole Shown
located at the
rearward /
lowest position
possible**

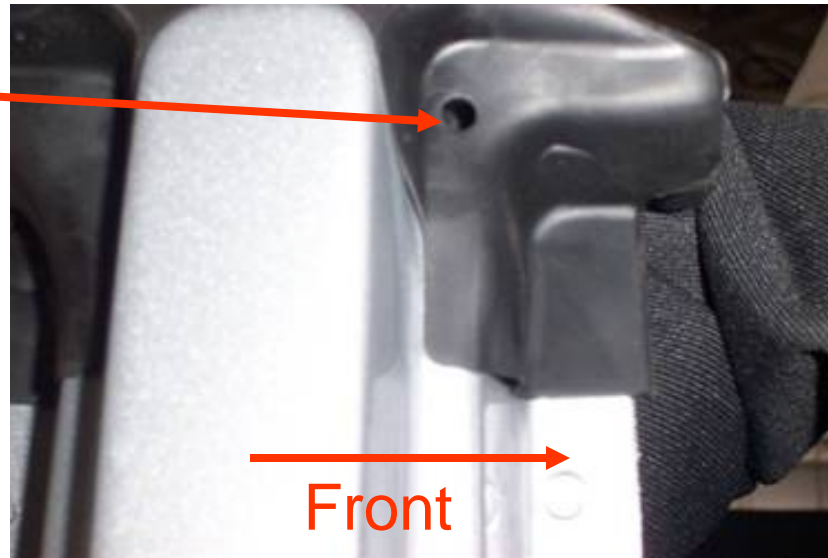

9/4/2008

Right B – Pillar ALL VIEWS

11

Foam Tape must be adhered to the front portion of the drain cup as shown to act as a dam



Left B – Pillar TOP VIEW

JK –Half Doors- Water Leak Repair

Measuring of Door Posts For Proper Preload



1. Lay Door on Flat Clean Surface.
2. Measure Posts.
3. Use Heat Gun to Heat up Posts as shown on page 3.
4. Slide Pipe over Posts and Bend to Correct Dimension as shown on page 3.

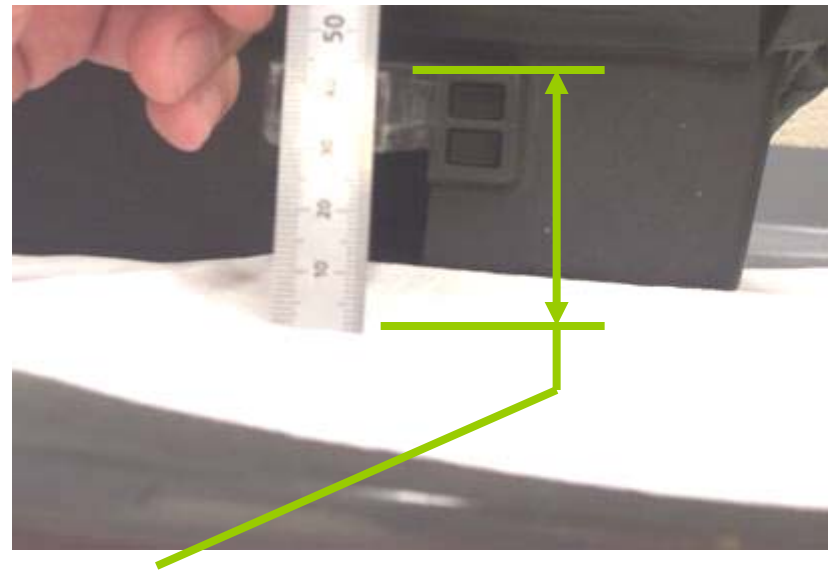

Set this dimension as shown to the upper edge of each peg to the dimensions shown on page 3



Heat Post: Caution too much heat will melt Door, Maintain 12 inches for 2 Min. Max

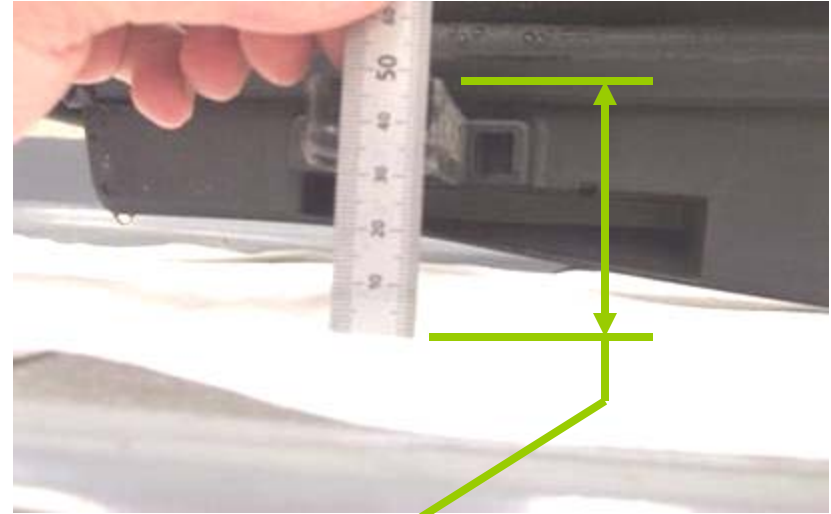

Once heated Slide Pipe Over Post and Bend Post to Correct Dimension



Front Door Post Dimensions (R & L)

Front Post	46.0mm
Rear Post	37.0mm

Rear Door Post Dimensions (R & L)

Front Post	30.0mm
Rear Post	40.0mm

9/4/2008 **Note: Dimensions are from flat surface to the top of post.**

Add **4 mm diameter bead 68027813AA** Butyl
Between Door Seal and door as shown on Page 5.



Front Door Upper "A" Pillar Corner

Add 4mm Diameter Butyl bead 6 inches forward, and 6 inches rearward as shown in RED

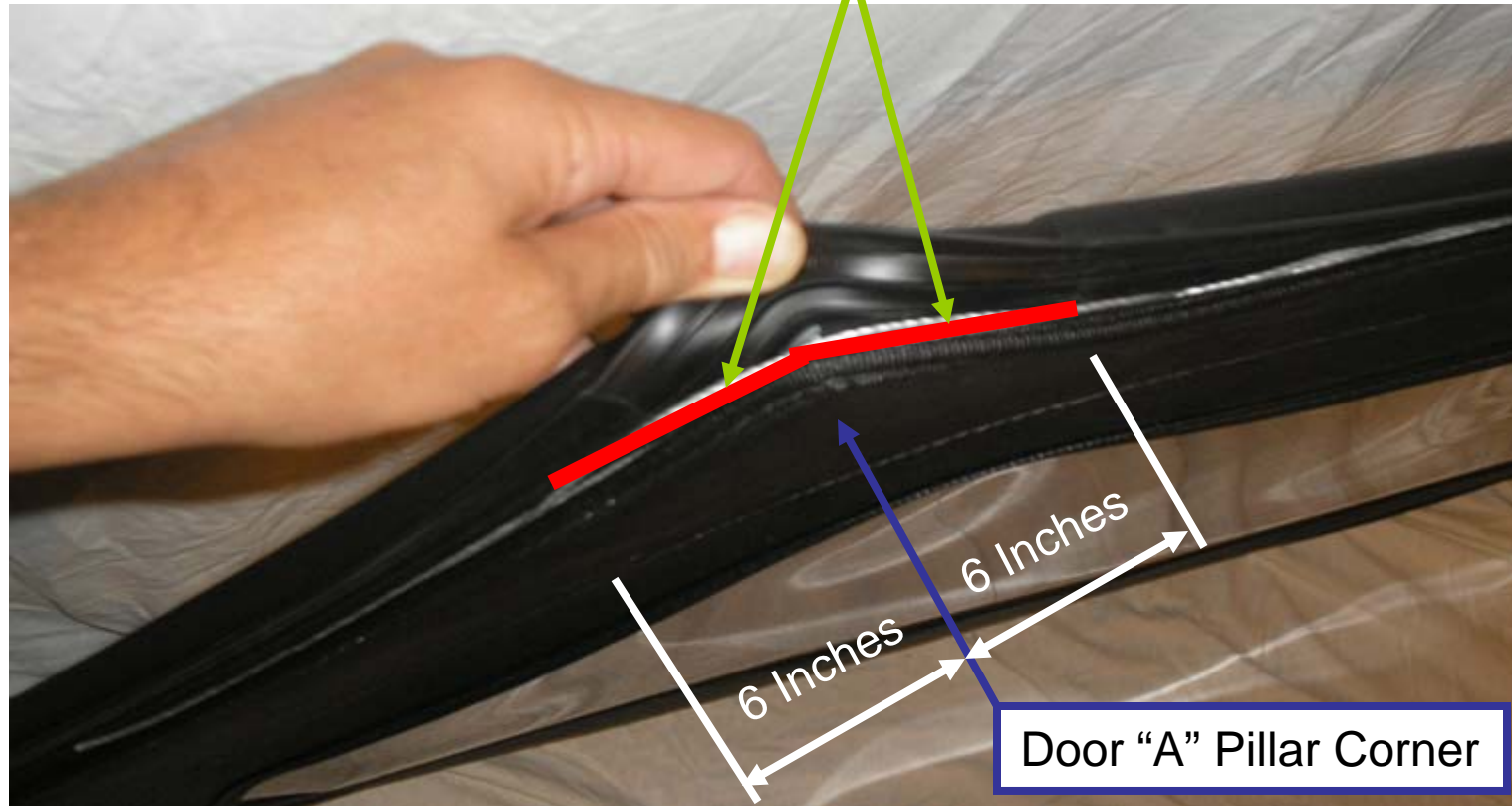

Close up view of area circled on page 4

Front of Door



Make Sure Seals Are Installed Correctly



Seal is not seated in channel



Correct

68003655AB KIT DOOR RAIL SEAL
4DR JK



9/4/2008

68003645AB KIT DOOR RAIL SEAL
2DR JK



9/4/2008

JK – Soft Top Water Leak Repair Tips



Header Seal Cup Folded under



Correct

10/14/2008

Proper Quarter Window Installation



Incorrect – Retainer Not Rolled into Door Rail



Correct

**Half Door, Side Curtain, or Rear Window Zipper Leaks
Can Be repaired by using Beeswax or Snow Seal as a
sealant.**



10/14/2008

Water Seeping Through Zipper
Tape or Zipper Teeth

68003655AB KIT DOOR RAIL SEAL
4DR JK



10/14/2008

68003645AB KIT DOOR RAIL SEAL
2DR JK

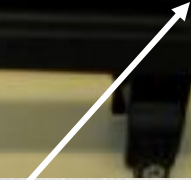

10/14/2008

JK Water Leak Foam Repair Kit – Supplemental Information

P/N 68026937AA

23-041-07 Soft Top – Water Leak at Upper A-Pillar, Door Seal to Door Rail Interface
23-001-07 Modular Hard Top Freedom Panel Water Leaks

Foam Kit includes the following foam pieces:

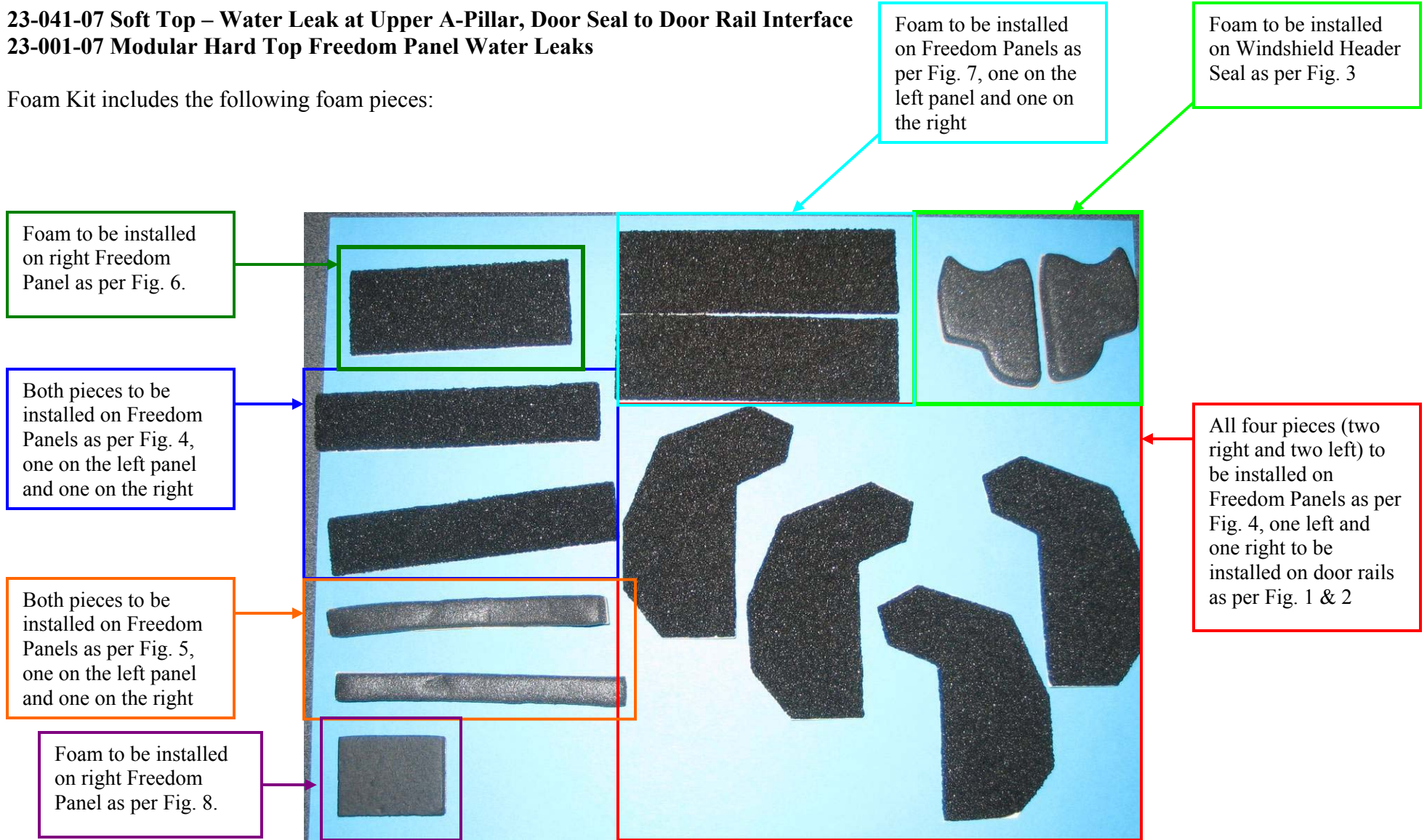

Reference – Foam Locations on Vehicle (Soft Tops)

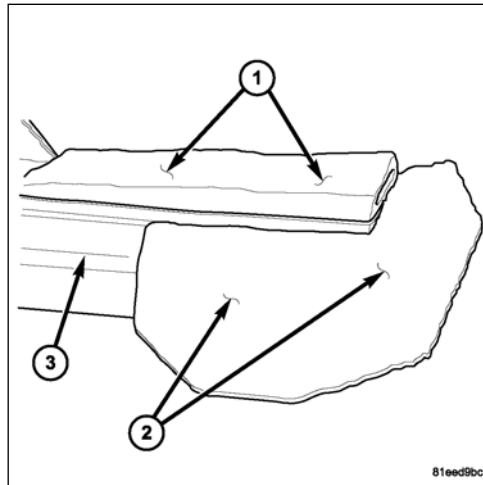
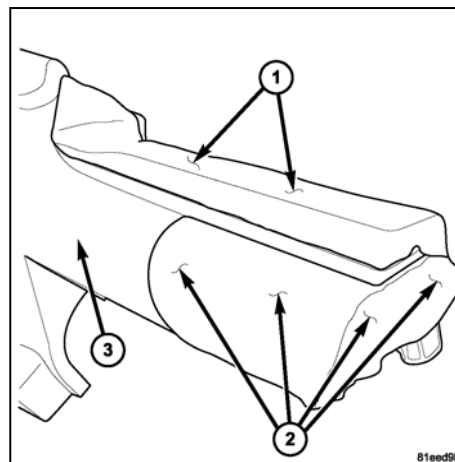

Figure 1 – Rough Position of Foam on Right Door Rail. Reference location **1** on both left and right sides of vehicle.

- (1) – Door frame rail foam
- (2) – New black foam (**Red** highlighted foam). One piece left handed and one piece right handed. Loose fit to door frame rail.
- (3) – Plastic door frame rail - Leading end/edge removed from vehicle to affect repair.



← **Figure 2** – Black Foam Fully Seated

Note – Ensure that header seal is not pinched under foam when re-installing the door rail.

Reference – Foam Locations on Vehicle (Hard Tops)

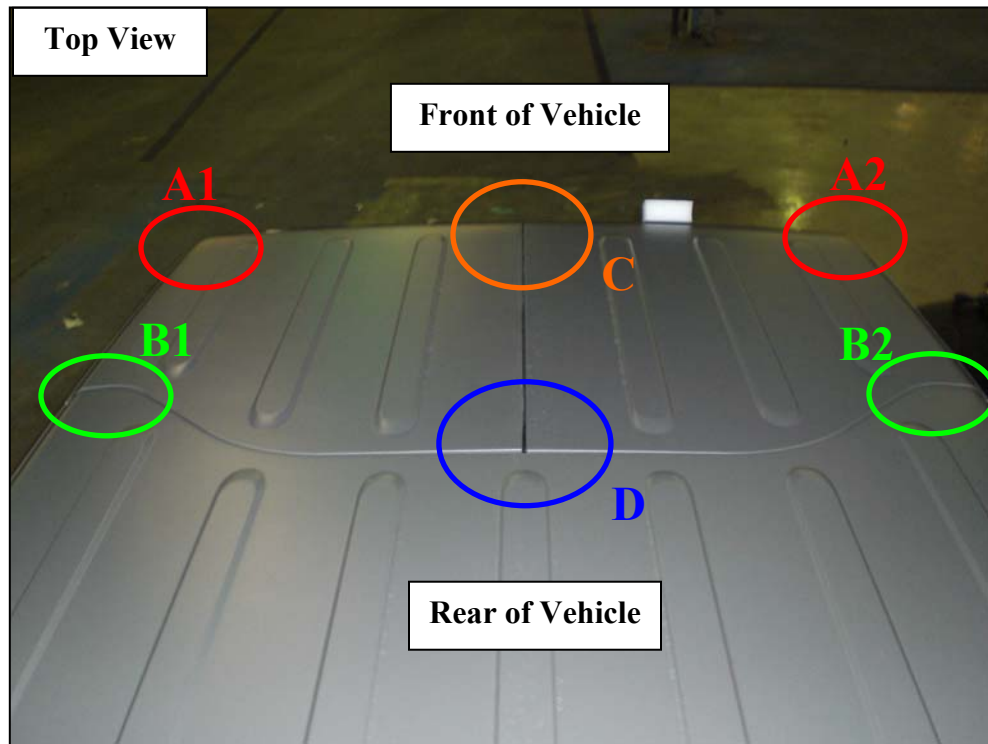
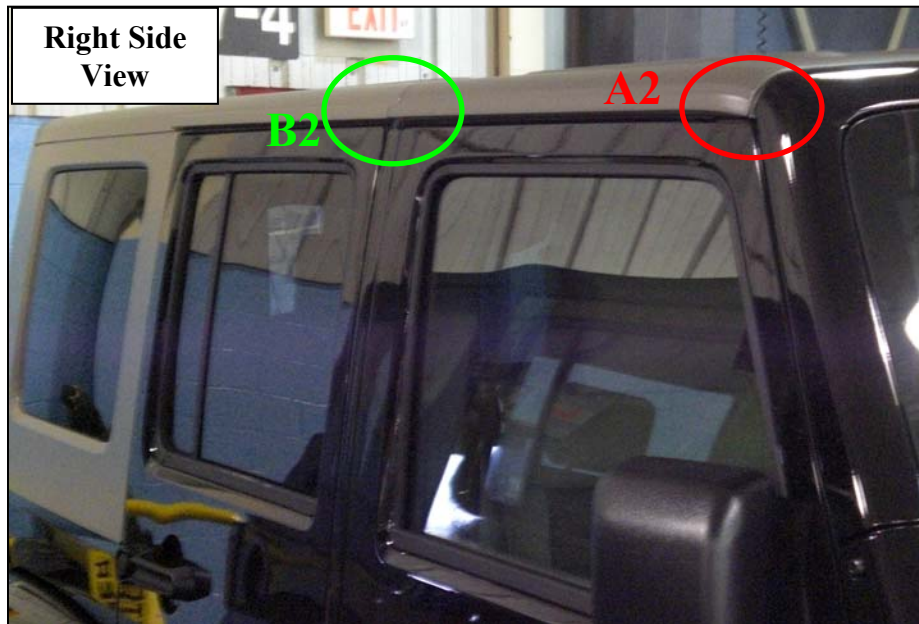
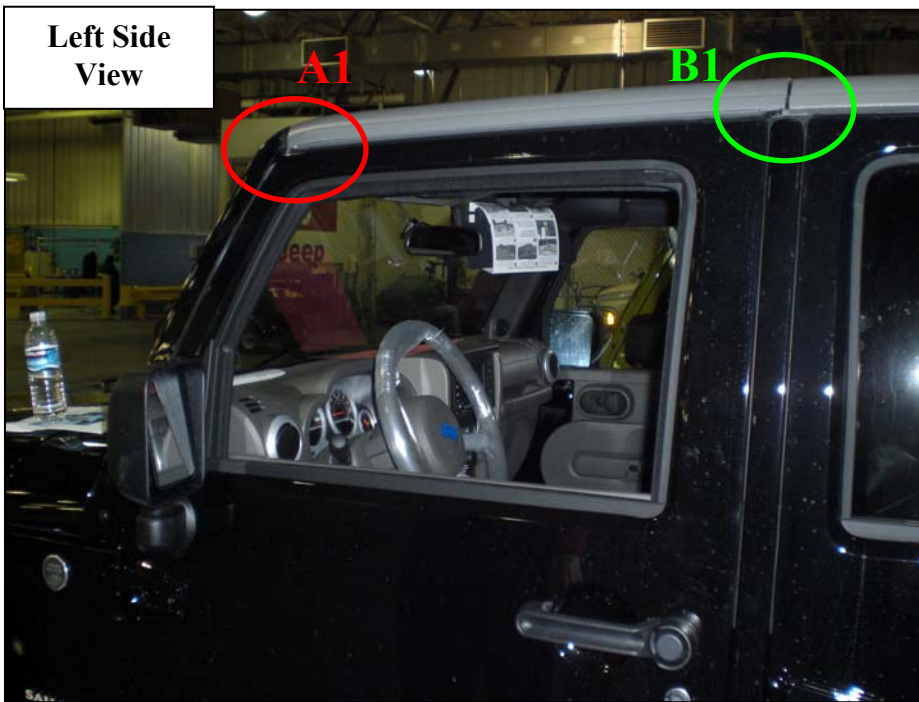

Figure 3 – Windshield Header Seal Molded Detail (Upper A-Pillar shown without tops)
Reference Locations **A1** & **A2**

- 1 - Dark Gray Foam at End of Header Seal - Left Side of Windshield Frame shown.
- 2 - Windshield Header Seal
- 3 - Windshield Frame - Upper A-Pillar - Left Side

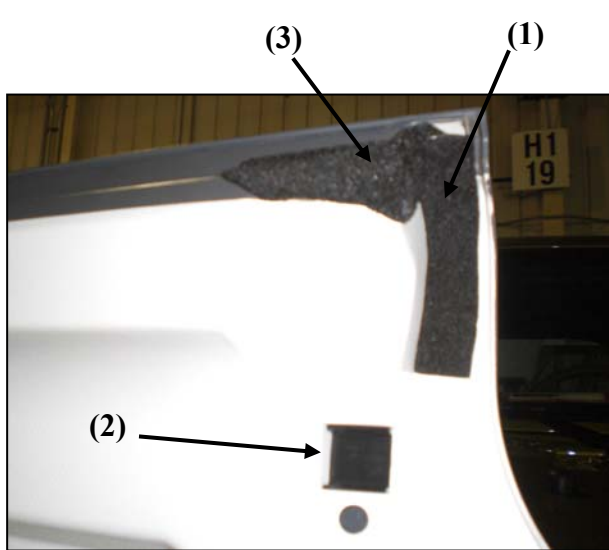
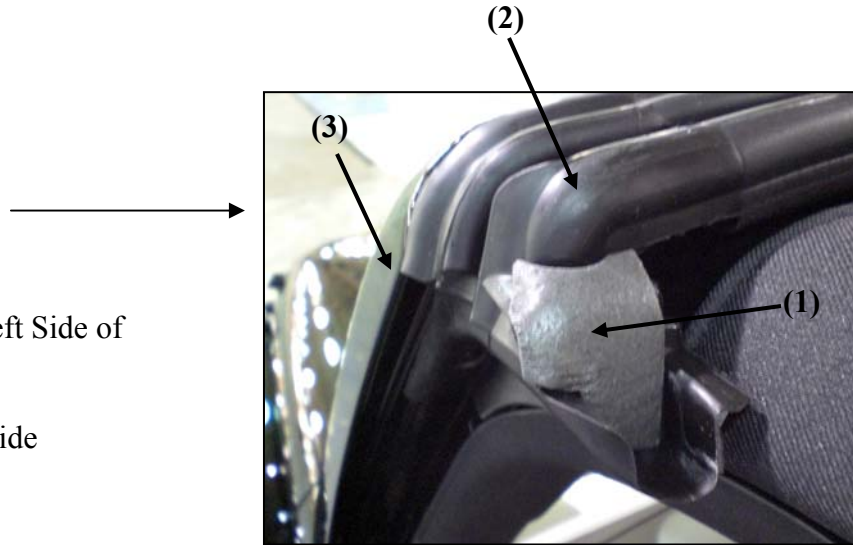

Figure 4 – Rear of left Freedom Panel shown.
Reference locations **B1** & **B2**.

- (1) – **Blue** highlighted foam
- (2) – 2-way freedom panel locator
- (3) - **Red** highlighted foam

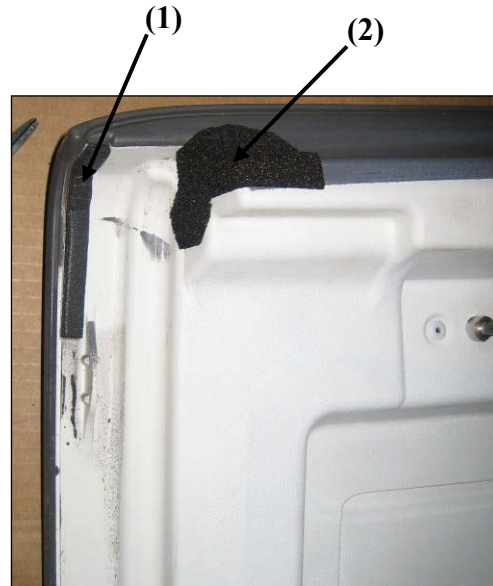

Figure 5 – Front of left Freedom Panel shown. Reference locations **A1** & **A2**.

- (1) - **Orange** highlighted foam
- (2) - **Red** highlighted foam



Figure 6 – Rear of right Freedom Panel shown.
Reference location **D**.

- (1) – **Dark green** highlighted foam

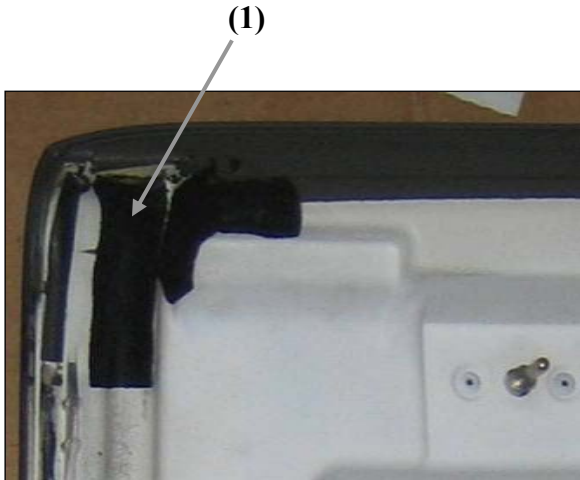

Figure 7 – Front of **left** Freedom Panel showing one additional foam, required only on vehicles built prior to 3/01/07. Reference locations **A1** & **A2**.

(1) – **Turquoise** highlighted foam

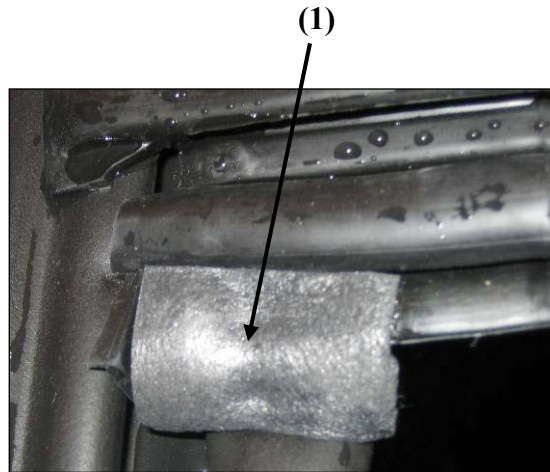
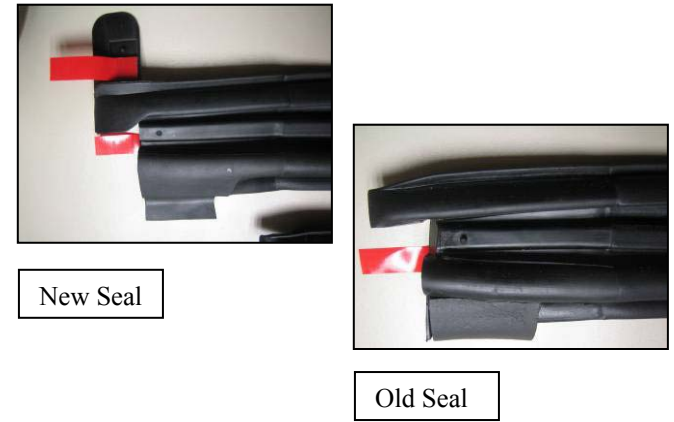

Figure 8 – Front of **right** freedom panel showing one additional foam, required on vehicles built prior to 3/27/07, unless a new seal was installed as shown by photos on side. Reference location **C**.

(1) – **Purple** highlighted foam



07 Wrangler Water Leak Repair

Water drips on A-pillar Trim or end of IP	Front Door	Out of spec door fit	Refit door if header gap to top is greater than 7mm or door overflush to A or B pillar greater than 1mm
		Header Seal ends offset to top panel or rail	Adjust bracket flange behind end detail in or out to flush up detail to top.
		Sealer skip/miss along back of Door Seal mounting Channel	Add repair sealer to close off sealer skip
		Door Primary seal not fully installed to channel on door	Reinstall loose sections into channel
		“Rolled” or distorted "cup" of windshield header seal or B-pillar seals	Reseat top to seal detail, straighten seal cup for smooth transition to top
		Distorted/folded Windshield -Cowl Seal end detail	Reseat seal detail to windshield frame
		Missing or off location Foam transition patch near Windshield - Cowl Seal	Relocate or replace foam seal
		Door Primary seal not sealing along body surfaces	Locate leak path during test. Verify seal condition is not damaged. Adjust door fit or add insert/stuffer to seal if required.

07 Wrangler Water Leak Repair

Water leaks down B-pillar Trim or along inner surface of door at B-pillar from door header	Front Door Upper B - Pillar, 2 or 4 door	Out of spec door fit	Refit door if header gap to top is greater than 7mm or door overflush to B or C pillar greater than 1mm
		Front "cup" of B-pillar mocket folded/distorted	Loosen or remove top, reseal & straighten mocket lip for smooth transition
		Hardtop Seal adhesive tape not wetout across end details & center detail	Inspect Hardtop seal center detail for leak paths and source. Refer to Hard top Outboard End Leak file for further information.

Water leaks down Rear Door opening at trim fabric, trim panel or door inner	4 Door - Rear Door Upper B-Pillar	Out of spec door fit	Refit door if header gap to top is greater than 7mm or door overflush to A or B pillar greater than 1mm
		Rear "cup" of B-pillar mocket folded/distorted	Loosen or remove top, reseal & straighten mocket lip for smooth transition
		Inconsistent Hardtop foam tape/butyl application at ends on 4 door top	Refer to Hard top Outboard End Leak file for further information
		If soft top, poor transition on B-pillar molded detail to rail may be present	Replace or relocate foam on rail to extend between 1mm-3mm past edge of seal lip.

07 Wrangler Water Leak Repair

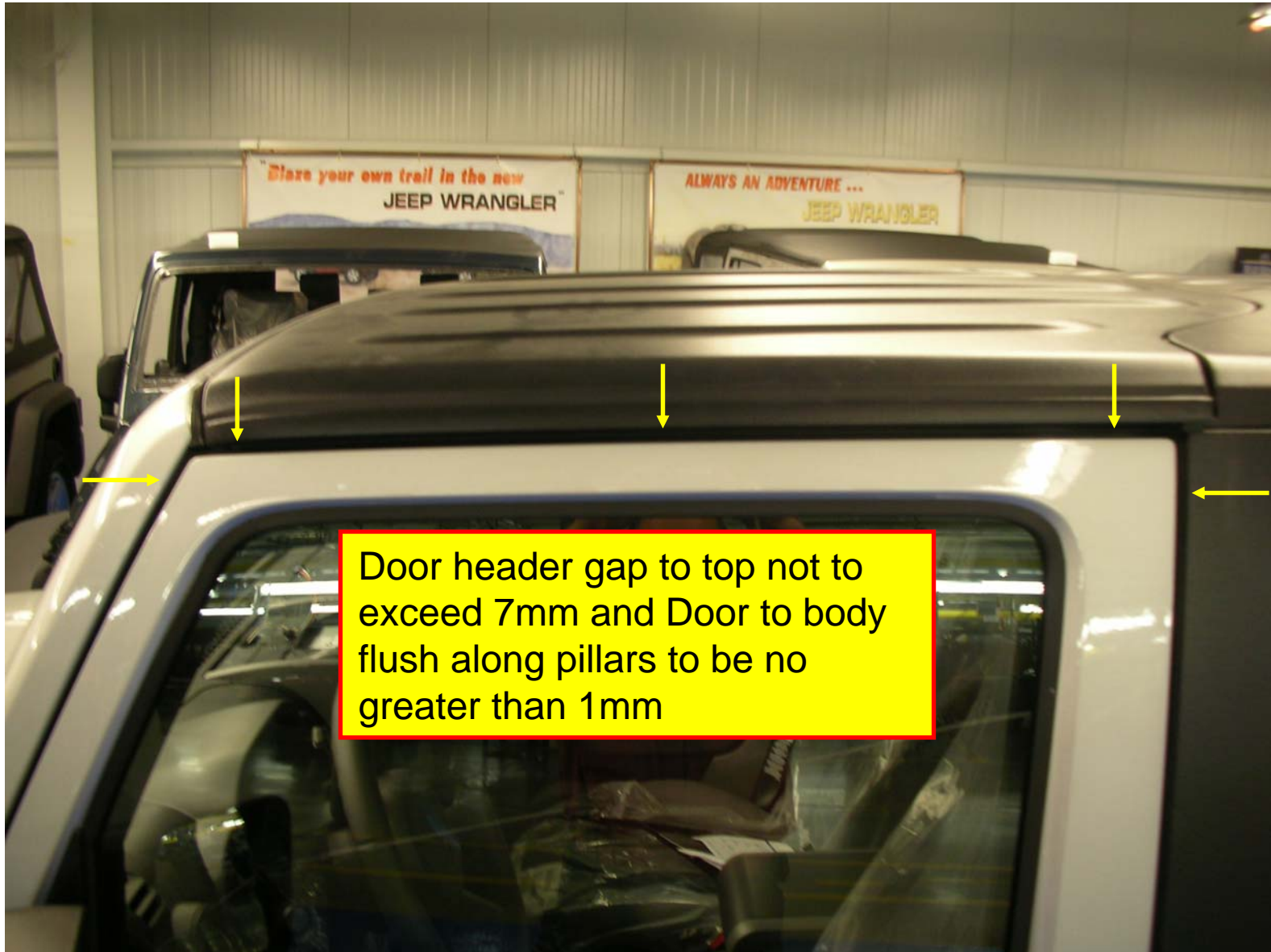

Doors

07 Wrangler Water Leak Repair

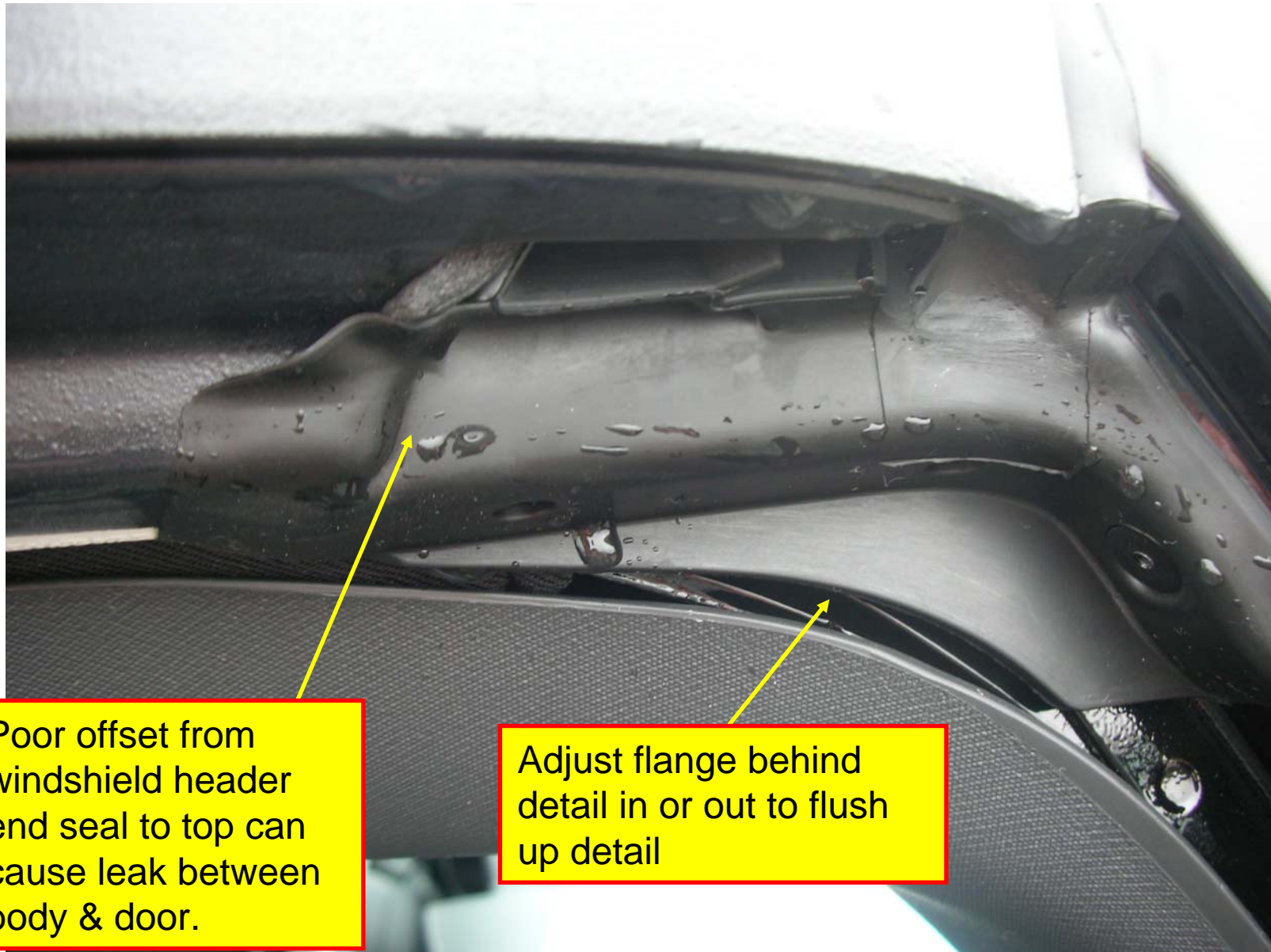

Poor offset from windshield header end seal to top can cause leak between body & door.

Adjust flange behind detail in or out to flush up detail

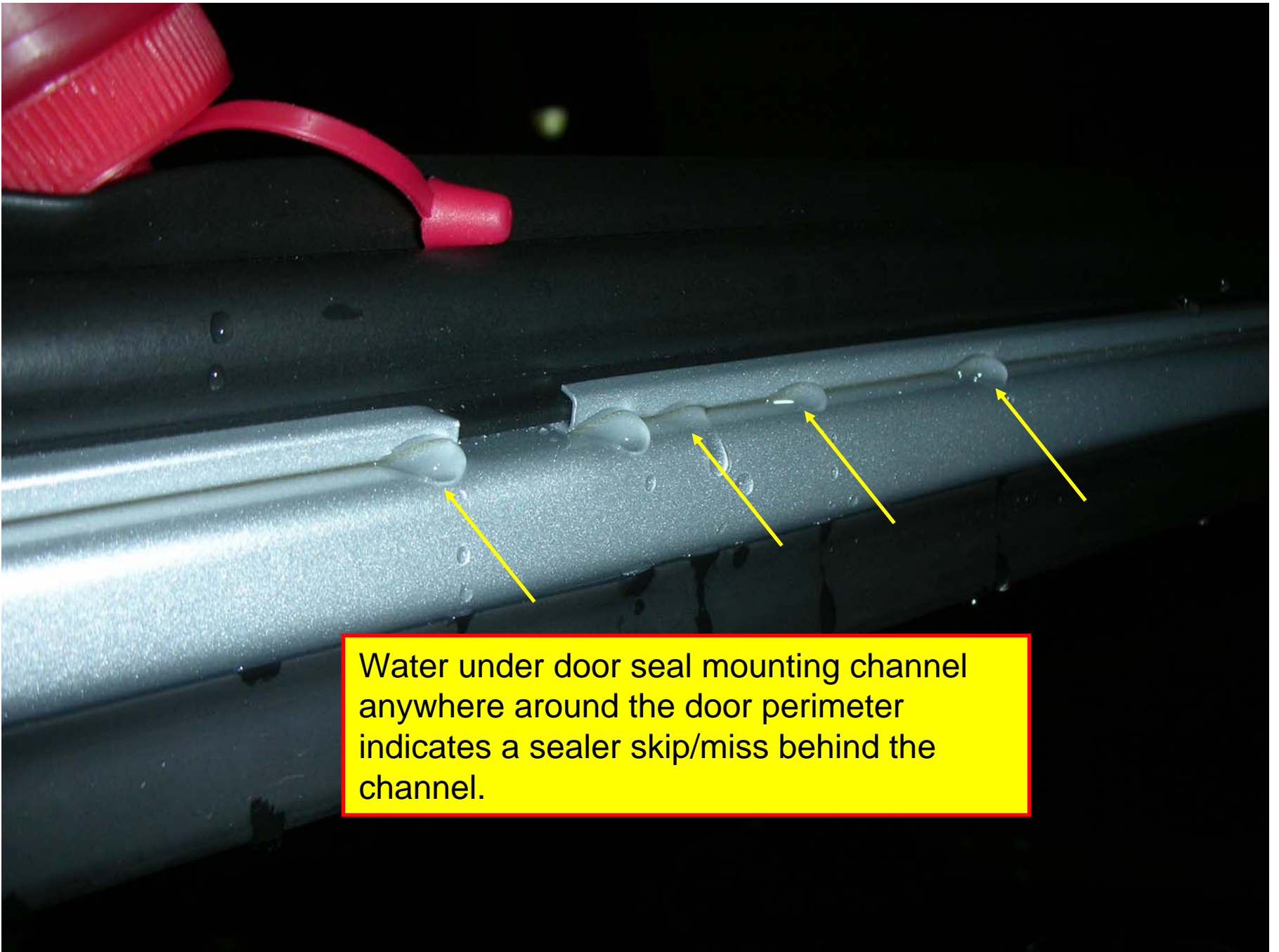

Water under door seal mounting channel anywhere around the door perimeter indicates a sealer skip/miss behind the channel.

07 Wrangler Water Leak Repair



“Rolled” or distorted windshield header end seals can cause leaks by making a poor transition for the primary seal to seal against.



07 Wrangler Water Leak Repair

“Rolled” or distorted B-pillar mocket seals can cause leaks by making a poor transition for the front or rear door primary seal to seal against.



07 Wrangler Water Leak Repair

Water path at missing or off location foam tape on windshield frame (shown in correct location).

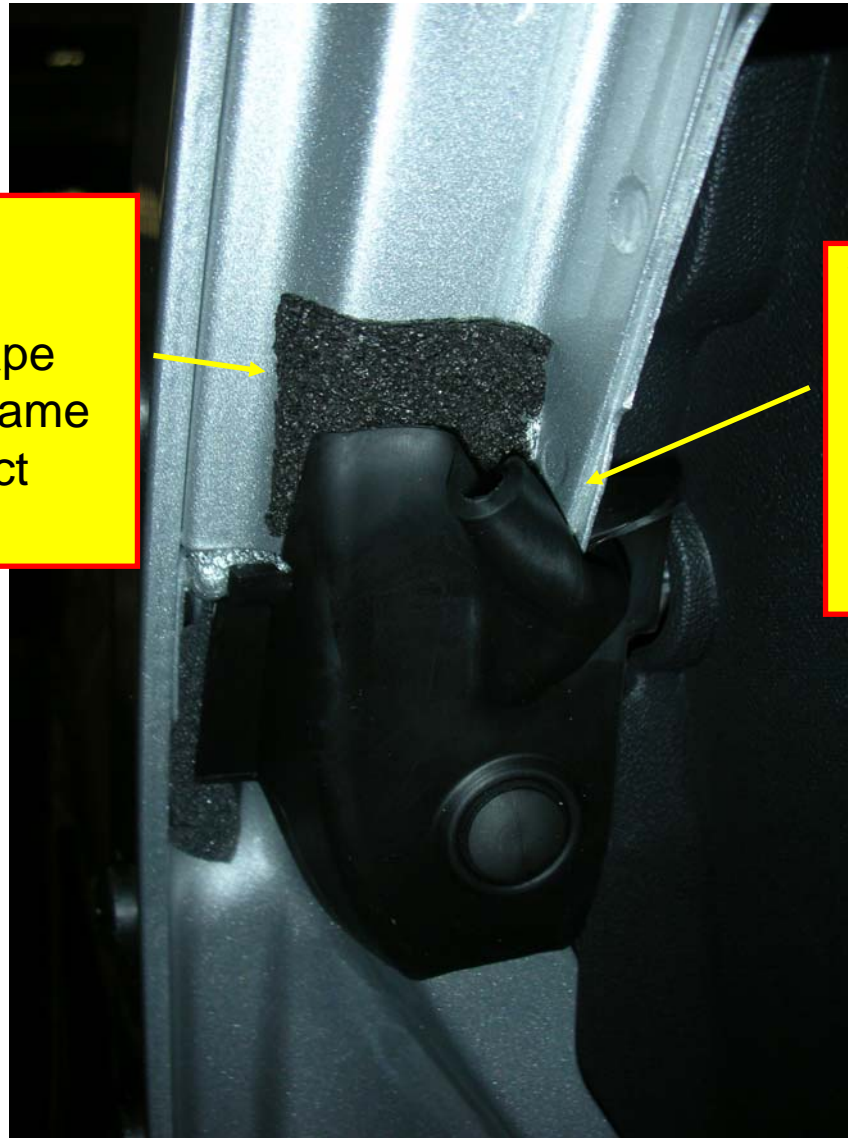

Windshield – Cowl Seal end detail must not be folded or distorted or a leak can result.

07 Wrangler Water Leak Repair



Water leak can occur
if door check strap
trapped in seal

Doors

07 Wrangler Water Leak Repair



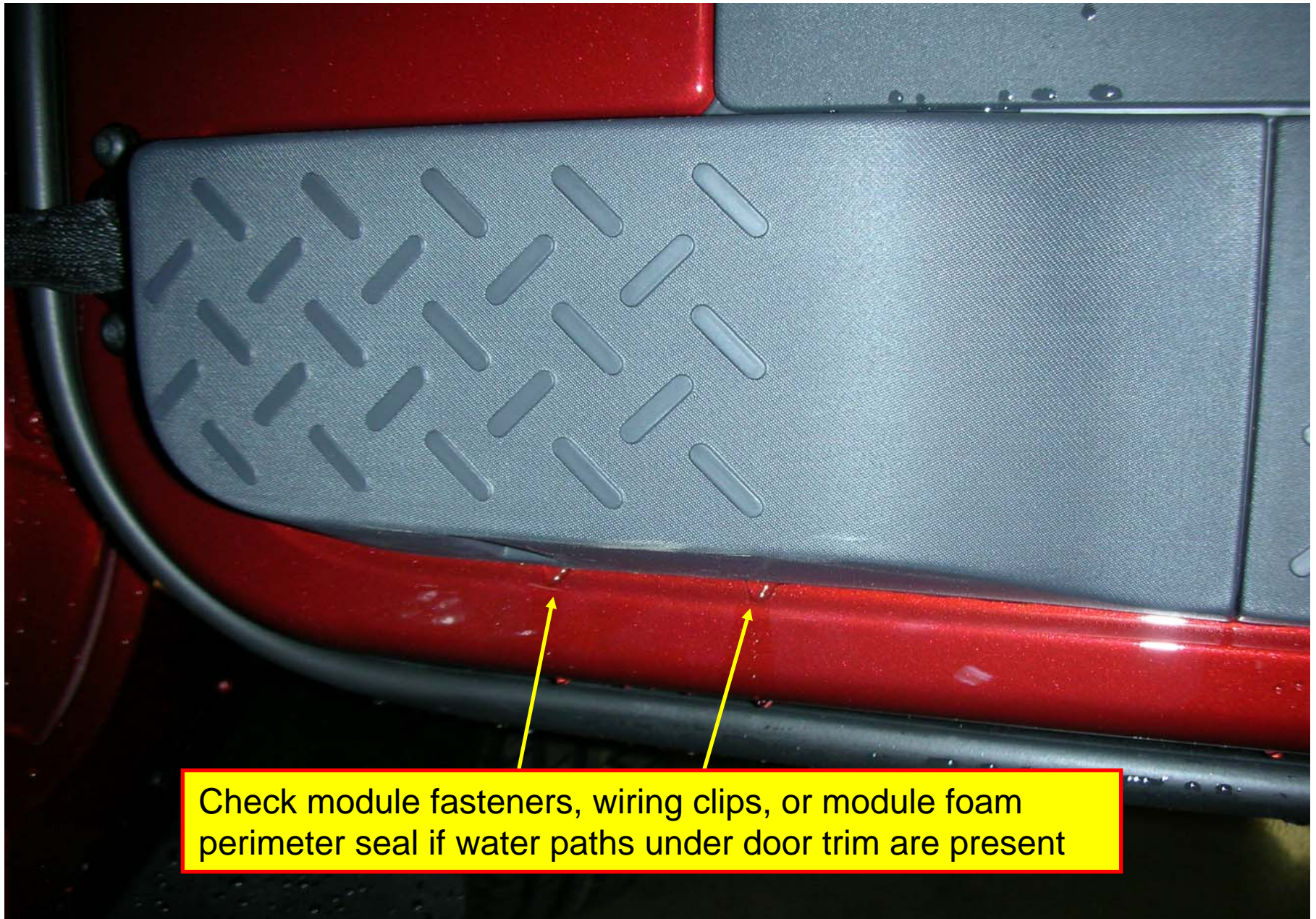

Check module fasteners, wiring clips, or module foam perimeter seal if water paths under door trim are present



NUMBER: 23-002-08

GROUP: Body

DATE: January 15, 2008

This bulletin is supplied as technical information only and is not an authorization for repair. No part of this publication may be reproduced, stored in a retrieval system, or transmitted, in any form or by any means, electronic, mechanical, photocopying, or otherwise, without written permission of Chrysler LLC.

THIS BULLETIN SUPERSEDES TECHNICAL SERVICE BULLETIN 23-041-07, DATED SEPTEMBER 29, 2007 WHICH SHOULD BE REMOVED FROM YOUR FILES. ALL REVISIONS ARE HIGHLIGHTED WITH **ASTERISKS**** AND INCLUDE THE ADDITION OF 2007 MODEL YEAR VEHICLES.**

SUBJECT:

Soft Top - Water Leak At Upper A-Pillar Door Seal To Door Rail Interface

OVERVIEW:

This bulletin involves the addition of foam to eliminate a possible water leak at the upper A-Pillar.

MODELS:

****2007**** - 2008 (JK) Wrangler

NOTE: This bulletin applies to vehicles equipped with a soft top (sales code GWK or VJ0) or with a dual top (sales code AEM).

SYMPTOM/CONDITION:

On soft top equipped vehicles, water may leak past the door seal to door rail interface at the upper A-Pillar.

DIAGNOSIS:

1. Verify that the soft top is correctly installed and fastened correctly to the vehicle. The soft top cover should be located and clamped in the correct sequence as described in the Owners Manual.
2. Apply water to the affected area for about 3 - 5 minutes while inspecting the interior of the vehicle for possible water leaks and leak source.
3. If the source of the water leak is from the interface of the door seal to the door rail at the upper A-Pillar, then perform the Repair Procedure.

PARTS REQUIRED:

Qty.	Part No.	Description
1	68026937AA	Kit, Replacement Foam (Repair)



Stick with the Specialists™

REPAIR PROCEDURE:

1. Fold back the entire soft top.
2. Remove the front left and right plastic door rail frame from the vehicle body.
3. Inspect the windshield header seal molded details to ensure that the dark gray foam is present and not damaged. The dark gray foam is located at each outer end of the windshield header seal. If the dark gray foam is damaged, remove the old foam and replace with new dark gray foam from the Replacement Foam Repair Kit (Fig. 1).

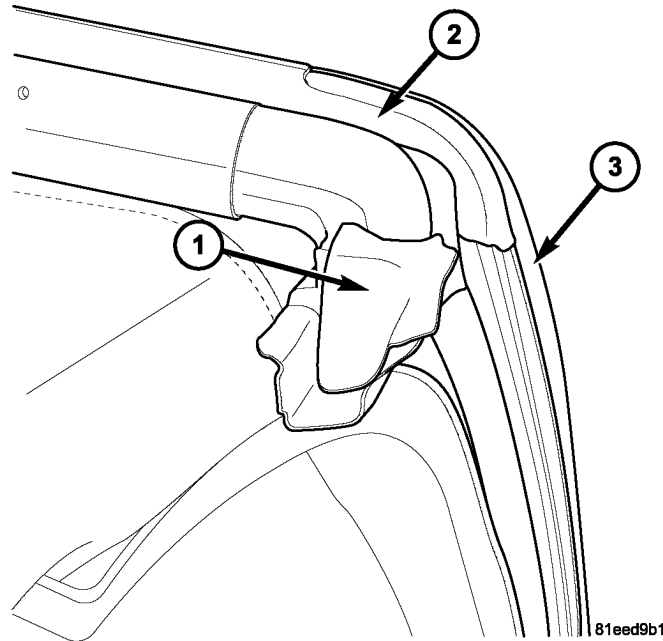
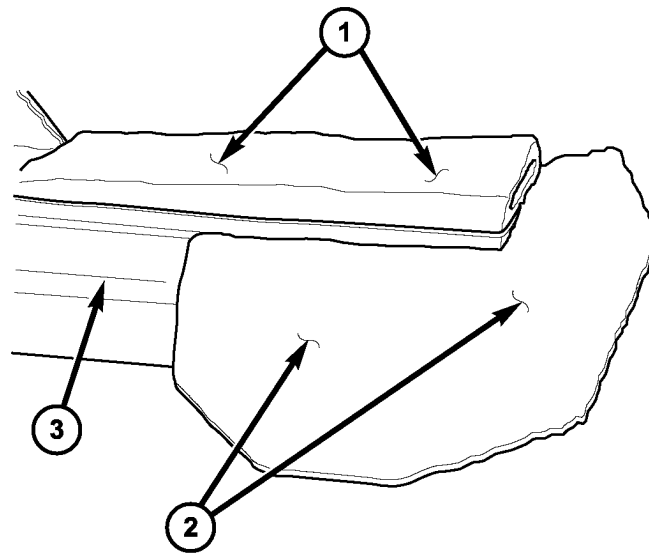

Fig. 1 DARK GRAY FOAM - HEADER SEAL

- 1 - Dark Gray Foam At End Of Header Seal - Right Side Of Windshield Frame Shown
 2 - Windshield Header Seal
 3 - Windshield Frame - Upper A-Pillar - Right Side

**NOTE: The Replacement Foam Repair Kit includes all foam pieces for the vehicle.
 Not all foam pieces in the kit will be required for this Repair Procedure.**

4. Obtain the black foam piece from the Replacement Foam Repair Kit. The black foam pieces are handed (one for the left side and one the right side). Select the correct side black foam piece.
5. Temporarily line up (loose fit) the perimeter of the black foam piece to the front edge of the door rail (Fig. 2).



81eed9bc

Fig. 2 BLACK FOAM - LOOSE FIT

- 1 - Door Frame Rail Foam
- 2 - New Black Foam (One Piece Left Handed and One Piece Right Handed) - Loose Fit To Door Frame Rail
- 3 - Plastic Door Frame Rail - Leading End/Edge - Removed From Vehicle To Effect Repair

-
6. Remove the white protective backing from the black foam piece and attach the black foam to the door rail.
 7. Wrap the black foam around the front edge of the door rail (Fig. 3).
 8. Complete the installation of the black foam the to door rail by wrapping the foam onto the underside of the door rail.
 9. Repeat the above procedure for the opposite side.
 10. Raise and install the soft top to the vehicle. It is important to install the soft top in the correct installation sequence as referenced in the Owners Manual.

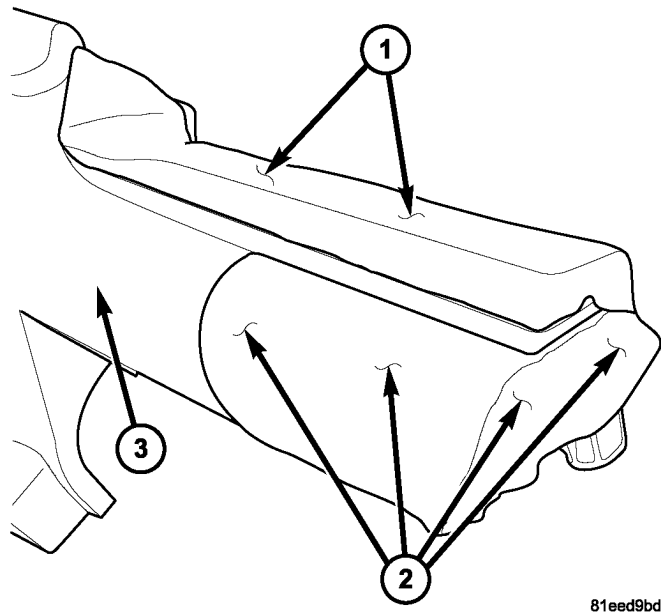

81eed9bd

Fig. 3 BLACK FOAM - FULLY SEATED

- 1 - Door Frame Rail Foam
- 2 - New Black Foam Piece From Replacement Foam Kit - Fully Seated To Door Frame Rail End And Side
- 3 - Plastic Door Frame Rail

POLICY:

Reimbursable within the provisions of the warranty.

TIME ALLOWANCE:

Labor Operation No:	Description	Amount
23-51-35-95	Water Leak Test At A-Pillar - Inspection (B)	0.2 Hrs.
23-51-35-96	Water Leak Test and Additional Foam - Install To Soft Top Door Rails (B)	0.9 Hrs.

FAILURE CODE:

ZZ	Service Action
----	----------------



NUMBER: 23-020-08

GROUP: Body

DATE: June 20, 2008

This bulletin is supplied as technical information only and is not an authorization for repair. No part of this publication may be reproduced, stored in a retrieval system, or transmitted, in any form or by any means, electronic, mechanical, photocopying, or otherwise, without written permission of Chrysler LLC.

THIS BULLETIN SUPERSEDES SERVICE BULLETINS 23-001-07 DATED JANUARY 06, 2007 AND 23-050-07, DATED NOVEMBER 21, 2007. THIS IS A COMPLETE REVISION AND NO ASTERISKS HAVE BEEN USED TO HIGHLIGHT REVISIONS.

SUBJECT:

Freedom Top - Center Seal - Water Leak In Area Of Center Console or Dash

OVERVIEW:

This bulletin involves the select replacement of: the center seal and its associated foam tape, butyl adhesive, and weatherstrips.

MODELS:

2007 - 2008 (JK) Wrangler

NOTE: This bulletin applies to vehicles equipped with a Freedom Top - Modular Hard Top

SYMPTOM/CONDITION:

On vehicles equipped with a Freedom Top a leak water may occur in the area of the hard top removable (targa) panels. This bulletin will address water leaks due to the **CENTER SEAL** of the removable Freedom Top (targa) panel.

If the center seal is at fault, the customer may experience a water leak in one of the following areas:

- a. On to the center console
- b. On to the center section of the instrument panel
- c. From the Freedom panel knob (dial) fasteners
- d. At the sports bar cloth covering inboard of the B-Pillar
- e. On to the front seat cushion or seat back

Water leaks may occur in other areas of the vehicle body that interface with the Freedom Top panels. These other areas may include: the A-Pillar, the B-Pillar, or the Door. Water leaks in these areas are addressed in other Service Bulletins. Refer to those Service Bulletins as necessary.

DIAGNOSIS:

1. Prior to performing this Service Bulletin refer to additional supporting material found in DealerCONNECT and TechCONNECT. At DealerCONNECT select: eFiles > Service (at left side of page) > Star Center > Misc Documents.
2. Determine the vehicle build date. Vehicles built on or before **December 17, 2007** (MDH 1217XX) will require the windshield header latch on each panel be replaced with the latest level latch.

NOTE: Installing the Freedom Top panels CORRECTLY is very important to prevent a water leak from occurring. Make sure the technician and customer know and use the correct installation and removal procedure. Follow the removal and installation steps in the correct order.

Fig. 1 HARD TOP INSIDE FULL VIEW

- 1 - Left Freedom Top Panel
 - 2 - Center L-Shaped Locks - Left Freedom Top Panel
 - 3 - Rear L-Shaped Lock at Seat Belt Anchorage - Left and Right Freedom Top Panel
 - 4 - Hard Top
 - 5 - B-Pillar
 - 6 - Right Freedom Top Panel
 - 7 - Rear Fastener (Dial) Knobs - Left and Right Freedom Top Panel
 - 8 - Windshield Header Latch - Left and Right Freedom Top Panel
-

3. Inspect the Freedom Top panels to ensure that they are installed correctly (Fig. 1). If not, then note this condition so that the correct procedure for installing the Freedom Top panels to the hard top can be reviewed with the customer. To ensure that the panels are installed correctly perform the following steps in order. **When installing each Freedom Top panel always close the windshield latch first .**
 - a. With both panels removed, carefully install the right side panel onto the hard top.
 - b. Make sure the sun visor is folded down and out of the way.
 - c. Latch the right header panel latch located at the top of the windshield.
 - d. Turn the right side panel rear L-shaped lock (located above the shoulder belt anchorage) so that it fully engages the hard top.
 - e. Turn the right side panel rear fastener knob (located on the overhead speaker bar assembly) clockwise until it is tight.
 - f. Carefully install the left side panel onto the hard top.
 - g. Make sure the sun visor is folded down and out of the way.
 - h. Latch the left header panel latch located at the top of the windshield.
 - i. Turn the left side panel rear L-shaped lock (located above the shoulder belt anchorage) so that it full engages the hard top.
 - j. Turn the left side panel rear fastener knob (located on the overhead speaker bar assembly) clockwise until it is tight.
 - k. Turn both center L-shaped locks (2) so that they fully engage the right side panel.
4. Have an assistant apply a slow flow of water across the hard top Freedom Top panel joints with a hose for approximately 3-5 minutes while inspecting the interior of the hard top for water leaks to determine general leak source location(s). Do not use a hard spray of water. Do not stop inspection when one leak source is located, there may be more than one water leak source.
5. Water leaks at the front of the vehicle, onto the center section of the instrument panel (IP) and/or onto the center console area, are indicators of a front center seal Freedom Top panel leak path. The water leak could be a rear center seal Freedom Top panel leak that travels forward. Water leaks could also be a result of poor contact between the windshield header weatherstrip seal and the Freedom Top panel center seal. If a water leak is in one or more of the areas described in this step, then perform the Repair Procedure in this Service Bulletin and refer to the DealerCONNECT file.
6. Water leaks from Freedom Top panel knob (dial) fasteners in speaker bar, leaks near the left or right B-Pillar onto sport bar cloth covering, or onto front seats are indicators of a water leak path from the rear section of the Freedom Top panel center seal. If a water leak is in one of more of the areas described in this step, then refer to the DealerCONNECT file.
7. Water leaks at the upper A-pillar that drip onto the outboard ends of the instrument panel is an indicator of a water leak path between the door inner panel or seal and the Freedom Top panel interface, and/or the windshield header seal. There also could be a water leak path at the radius of windshield header area. If a water leak is in one of these areas then this Service Bulletin does not apply. Refer to the DealerCONNECT A-Pillar file.
8. Water leaks at the upper B-Pillar outboard of the sport bar that drip onto the B-Pillar hard trim panel is an indicator of a water leak path between the hard top and the Freedom Top panel, or a water leak path under the hard top seal. If a water leak is in this area then this Service Bulletin does not apply. Refer to the DealerCONNECT file.
9. Water leaks at the upper B-Pillar outboard of the sport bar that drip onto the inner surface of the door panel at the B-Pillar is an indicator of a water leak path between the door inner panel or seal and the Freedom Top panel interface. If a water leak is in this area then this Service Bulletin does not apply. Refer to the DealerCONNECT file.

PARTS REQUIRED:

Qty.	Part No.	Description
AR (1)	68026937AB	Kit, Replacement Foam
AR (1)	55397095AG	Seal, Targa Top (Right Freedom Top Panel Center) DO NOT use previous versions of this seal
AR (2)	68004562AB	Latch, Targa Panel Header
AR (1)	NPN	Adhesive Remover or Equivalent (such as: 08984 - 3M General Purpose Adhesive Cleaner or 20005 - Kent Products Acrysol)
AR (1)	04467709	Mopar Bond-All Gel (or equivalent)
AR (1)	NPN	Adhesive Promoter or Equivalent (such as: 4298 - 3M Adhesive Promoter)
AR (1)	NPN	Alcohol
AR (1)	NPN	Scotch Bite Pad
AR (2)	68046593AA	Butyl, Tape - 60 mm length x 12 mm wide x 2 mm height - strip
AR (6)	68027813AA	Butyl, Tape - 4 mm dia. x 152 mm (6 inch) length - strip
AR (3)	68048423AA	Butyl, Tape - 4 mm dia. x 1,830 mm (6 ft.) length - roll
AR (2)	68004991AA	Isolator, Targa Top (Freedom Top Panel) Plastic

Fig. 2 HARD TOP SEALS

- 1 - B-Pillar Cup - Hard Top Seal - Left and Right Side
 - 2 - Hard Top Seal
 - 3 - Center Cup - Hard Top Seal
 - 4 - Left Freedom Top Panel
 - 5 - Center Seal - Right Freedom Top Panel
 - 6 - Windshield Header Seal
 - 7 - A-Pillar Cup - Windshield Header Seal - Left and Right Side
 - 8 - Windshield Cowl Seal
 - 9 - Right Freedom Top Panel
 - 10 - Door Seal
 - 11 - B-Pillar Mocket - Left and Right Side
-

Fig. 3 REPLACEMENT FOAM KIT

- 1 - Black Foam Corner Patch D-972-E - Used At: Front and Rear Outboard Corners on RIGHT Freedom Top Panel
 - 2 - Black Foam Corner Patch D-973-E - Used At: Front and Rear Outboard Corners on LEFT Freedom Top Panel
 - 3 - Black Foam Patch D-1010-A - 30mm x 95mm x 3mm thick - Used At: Front Outboard Corner (Lt and Rt Panels) to Header Seal
 - 4 - Black Foam Patch D-1011-A - 30mm x 75mm x 3mm thick - Used At: Rear Inboard Corner (Left and Right Panels) Interface
 - 5 - Black Foam Patch D-1009-A - 20mm x 95mm x 5mm thick - Used At: Rear Outboard Corner (Lt And Rt Panels) to Hard Top Seal
 - 6 - Center Seal End Molded Detail Round Stuffer C-5164 - 7mm OD x 72mm - Used At: Frt and Rr Molded Detail Sections of Center Seal
 - 7 - Windshield Header Seal Round Stuffer C-5165 - 13mm OD x 8mm ID x 160mm - Used At: Placed Inside Windshield Header Seal Bulb
 - 8 - Gray Foam Patch C-5166 - 30mm x 75mm x 2mm thick - Used At: On Flame Tip of Front Molded Detail Section of Center Seal
 - 9 - Gray Foam Strip D-1012 - 9mm x 100mm x 6.35mm thick - Used At: Front Outboard Corner (Lt and Rt Panels) to Header Seal
-

REPAIR PROCEDURE:

NOTE: Do not use RTV as a sealer. Over time RTV will not remain attached to the hard top material.

NOTE: If seal requires replacement, then the old seal adhesive must be completely removed before a new seal is installed. Use a GOOD quality adhesive remover as recommended in Parts Required section of this Service Bulletin.

NOTE: All steps must be followed in order and completed fully. Do not omit any steps. Make sure the correct adhesive remover cleaner, alcohol, adhesive promoter, new butyl, replacement foam kit, and center seal are available prior to proceeding with this repair. Make sure the paint surfaces of the panels will be well protected to prevent scratches or other damage.

1. Remove both Freedom Top Panels from the hard top (Fig. 1). Perform the following steps in order:
 - a. At the left panel, make sure the left sun visor is folded down and out of the way.
 - b. Turn both left panel center L-shaped locks (2) so that they disengage from the right side panel.
 - c. Turn the left panel rear L-shaped lock (located above the shoulder belt anchorage) so that it disengages from the hard top.
 - d. Turn the left panel rear fastener knob (located on the overhead speaker bar assembly) counter-clockwise until it can be removed.
 - e. Unlatch the left panel header panel latch located at the top of the windshield.
 - f. Carefully remove the left side panel from the hard top.
 - g. At the right panel, make sure the right sun visor is folded down and out of the way.
 - h. Turn the right panel rear L-shaped lock (located above the shoulder belt anchorage) so that it disengages from the hard top.
 - i. Turn the right panel rear fastener knob (located on the overhead speaker bar assembly) counter-clockwise until it can be removed.
 - j. Unlatch the right panel header panel latch located at the top of the windshield.

- k. Carefully remove the right side panel from the hard top.
2. Set the Freedom Top panels on a well **PROTECTED WORK SURFACE**. Protect the Freedom Top panel edges & top surface from damage.

NOTE: THE PAINTED TOP SURFACE OF THE FREEDOM TOP CAN EASILY BE DAMAGED IF CARE IS NOT TAKEN TO PROTECT IT.

Fig. 4 RIGHT FREEDOM PANEL COMPONENTS

- 1 - Black Foam Corner Patch D-972-E and Black Foam Patch D-1010-A - 30mm x 95mm x 3mm thick
- 2 - Gray Foam Strip D-1012 - 9mm x 100mm x 6.35mm thick
- 3 - Front Outboard Corner
- 4 - Windshield Header Latch
- 5 - Front Side Surface - Right Freedom Top Panel to Windshield Header Panel and Header Seal
- 6 - Front Inboard Corner, Front Molded Detail Section of Center Seal, and Gray Foam Patch C-5166 - 30mm x 75mm x 2mm thick
- 7 - Inboard Side Surface - Right Freedom Top Panel with Center Seal
- 8 - Rear Inboard Corner, Rear Molded Detail Section of Center Seal, and Black Foam Patch D-1011-A - 30mm x 75mm x 3mm thick
- 9 - Spacer Blocker and Rear Thumb (Dial) Screw Attachment
- 10 - Rear Side Surface - Right Freedom Top Panel to Hard Top and Hard Top Seal
- 11 - Rear L-Shaped Lock at Shoulder Belt Anchorage
- 12 - Isolator Pad - Black Plastic
- 13 - Rear Outboard Corner
- 14 - Black Foam Corner Patch D-972-E and Black Foam Patch D-1009-A - 20mm x 95mm x 5mm thick
- 15 - Right Freedom Top Panel
- 16 - Locator Pin - Diameter Sizes of: 6.0 mm, 8.0 mm, or 9.5 mm
- 17 - Outboard Side Surface - Right Freedom Top Panel to Door Seal, A-Pillar Cup, and B-Pillar Cup and Mocket

Fig. 5 REMOVE OLD CENTER SEAL AND BUTYL

- 1 - Old Center Seal
- 2 - Right Freedom Top Panel
- 3 - Old Butyl Adhesive - All Old Adhesive, Sealants, Oil, Debris Must Be Removed / Cleaned From Panel

3. Remove the old center seal from the right Freedom Top panel ([Fig. 5](#)).

Fig. 6 REMOVE ALL OLD BUTYL

1 - Right Freedom Top Panel

2 - Old Butyl Adhesive In Front and Rear Inboard Corner Notches - All Old Adhesive, Sealants, Oil, Debris MUST Be Removed and Cleaned From Panel

-
4. Clean ALL old butyl adhesive from the Freedom Top panel center seal surface, inboard corners, and notches. Wipe the panel surface clean where the new seal will attach with a high quality adhesive remover (Fig. 6).
 5. Using a Scotch Bite pad, rough up the right panel surface where the center seal will make contact. Remove all residue with alcohol. Allow to dry completely.

NOTE: ALL old adhesive, sealant, oils, debris MUST BE thoroughly removed from the Freedom Top panel surface and inboard corner notches. Use a high quality adhesive remover and a small pick to remove the remaining old adhesive. Once the old adhesive has been removed, thoroughly clean and prep the entire surface for the new seal by removing any residual adhesive and oils with the high quality adhesive remover.

Fig. 7 CENTER SEAL SECTIONS

1 - Front Molded Detail Section

2 - Middle Extruded Section

3 - Rear Molded Detail Section

The new center seal is made up of three sections: a 70 mm long front molded detail section, a long middle extruded section, and a 70 mm long rear molded detail (Fig. 7). Both front and rear molded details have adhesive backing tape. The technician will need to add **NEW** butyl adhesive to the front and rear inboard corner notches to further assist with attaching the details to the panel and to prevent a water leak path. The middle extruded section of the center seal comes with NEW butyl adhesive that is protected by backing tape prior to installation.

When the new center seal is installed to the Freedom Top panel, the technician will need to ensure: that all three sections of the center seal are firmly affixed by their adhesives to the panel, that there are no water leak paths, and that the front and rear molded details make a gradual and smooth transition when they mate to the windshield header seal at the front and to the hard top seal at the rear.

To install a new center seal, the front and rear sections are attached to the right Freedom Top panel first, followed by the installation of the center section of the seal to the panel. The front and rear molded detail sections must be firmly in place, and must not move out of place when the middle section of the center seal is installed. To accomplish this, the middle section of the center seal is attached to the panel starting at the ends of the seal and working toward the center of seal. Care must be taken to make sure that the front and rear molded ends of the seal do not move, yet making sure that the middle section of the

seal is not bunched up at the center when it is installed.

Apply New Butyl Adhesive To Panel Front Inboard Corner:

6. On the right Freedom Top panel, locate the front inboard corner. Turn the right Freedom Top panel over so that the inside surface of the panel is facing up (outside surface of panel is resting on the protected work surface).
7. At the front inner corner of the panel, loose fit (do not attach at this time) the front molded detail of the new center seal to the front inner corner. Note and mark where the front molded detail wraps at the intersecting edges of the front corner. This is where new butyl adhesive will need to be applied. DO NOT reuse any old butyl adhesive.
8. Add **NEW** butyl adhesive (4 mm dia.) to the front inner corner of the right Freedom Top panel. The butyl adhesive is to run along both intersecting edges of the inner corner. Make certain there is sufficient butyl along each intersecting edge of the front corner to fully cover the molded detail ([Fig. 8](#)). Make sure the new butyl adhesive is on the edge and must be in the groove in all areas before the front molded detail is installed. Later when the front molded detail is installed and pressed in place, the new butyl will migrate into the groove areas.

Fig. 8 FRONT NOTCH - BUTYL APPLICATION

- 1 - Windshield Header Surface Side and Guide - Right Freedom Top Panel
 - 2 - New Butyl Adhesive - 4 mm in diameter - Apply Per Dimensions Shown - Apply Along Outer Edge - Push In Place
 - 3 - Front Inboard Corner - Right Freedom Top Panel
 - 4 - Center Seal Side - Right Freedom Top Panel
-

Apply New Butyl Adhesive To Panel Rear Inboard Corner:

9. Move to the rear inboard corner of the panel and the rear molded detail.
10. At the rear inner corner of the panel, loose fit the rear molded detail of the new center seal to the rear inner corner. Note and mark where the rear molded detail wraps at the intersecting edges of the rear corner. This is where new butyl adhesive will need to be applied. Do not reuse any old butyl adhesive.
11. Add **NEW** butyl adhesive (4 mm in dia.) to the rear inner corner of the right Freedom Top panel. The butyl adhesive is to run along both intersecting edges of the rear inner corner. Make certain there is sufficient new butyl along each intersecting edge of the rear corner to fully cover the molded detail. Make sure the new butyl adhesive is on the edge and must be in the groove in all areas before the rear molded detail is installed. Later when the rear molded detail is installed and pressed in place, the new butyl will migrate into the groove areas.

Fig. 9 REAR NOTCH - BUTYL APPLICATION

- 1 - Hard Top Surface Side - Right Freedom Top Panel
 - 2 - Center Seal Surface Side - Right Freedom Top Panel
 - 3 - New Butyl Adhesive - 4 mm in Diameter - Apply Per Dimensions Shown - Apply Along Outer Edge - Push In Place
 - 4 - Rear Inboard Corner and Notch - Right Freedom Top Panel
-

Attach Front Molded Detail Section of the Center Seal:***Fig. 10 PRESS FRONT DETAIL INTO PLACE***

- 1 - Center Seal Surface Side - Right Freedom Top Panel
 - 2 - Front Inboard Corner - Right Freedom Top Panel
 - 3 - "Flame Tip" - Front Molded Detail Section
 - 4 - Front Molded Detail Section - Firmly Press Into Place - Remove Any Excess (proud) Butyl Adhesive
-

12. Align the front molded detail to the front inboard corner of the right Freedom Top panel ([Fig. 10](#)).
13. Firmly press the front molded detail of the center seal to the front inboard corner of the panel. Verify that the new butyl adhesive is in full contact with the molded detail and is well compressed.
14. The butyl adhesive should be flush with the panel bottom surface. Remove any excess butyl adhesive that is proud of the panel bottom surface. This will help to ensure a smooth transition at the front end of the new center seal.
15. Remove the release tape from the front molded detail and firmly press the adhesive tape of the front molded detail to the panel.

Attach Rear Molded Detail Section of the Center Seal:

16. Align the rear molded detail to the rear inboard corner of the right Freedom Top panel.
17. Firmly press the rear molded detail of the center seal to the rear inboard corner of the panel. Verify that the new butyl adhesive is in full contact with the molded detail and is well compressed.
18. The butyl adhesive should be flush with the panel bottom surface. Remove any excess butyl adhesive that is proud of the panel bottom surface. This will help to ensure a smooth transition at the rear end of the new center seal.
19. At the rear molded detail, remove the release tape and firmly press the rear molded detail adhesive tape to the panel.

Fig. 11 PRESS REAR DETAIL INTO PLACE

- 1 - Release Tab - Adhesive Backing Tape
 - 2 - New Butyl Adhesive - 4 mm Diameter
 - 3 - Rear Inboard Corner and Notch - Right Freedom Top Panel
 - 4 - Center Seal Surface Side - Right Freedom Top Panel
 - 5 - Center Seal
 - 6 - Rear Molded Detail Section - Firmly Press Into Place - Remove Any Excess (proud) Butyl Adhesive
-

Replace Right Panel Header Latch:

20. If vehicle was built prior to December 17, 2007 (MDH 1217XX), then replace the right panel header latch ([Fig. 1](#)).

Attach Middle Section of the Center Seal:

Fig. 12 MIDDLE SECTION OF CENTER SEAL

- 1 - Right Freedom Top Panel
 - 2 - Middle Section - Center Seal - Still Unattached Until Now
-

Fig. 13 CENTER SEAL CROSS SECTION

- 1 - New Center Seal
 - 2 - Cross Section - Right Freedom Top Panel
 - 3 - Center Seal Channel and Panel Indexing Ridge
-

21. With both front and rear molded detail sections attached, move to the middle section of the center seal.
22. Note that at this point that both ends (front and rear molded details) of the center seal are attached, but the middle section of the center seal is not yet attached ([Fig. 12](#)). Note how the middle section of the center seal will engage the alignment ridge on the panel ([Fig. 13](#)).
23. Carefully turn right panel over so that the top (painted) surface is facing up.
24. When installing the middle section of the center seal take care not to allow the middle section of the seal to bunch up at the center. This could cause a water leak path.
25. Starting at one end, remove a few inches of the release tape and press the center seal into place. Move to the other end of the center seal, and remove a few inches of the release tape and press the center seal into place. Alternate back and forth from end to end working towards the center until the release tape is completely removed and the center seal is in place.

Fig. 14 FIRMLY PRESS SEAL INTO PLACE

- 1 - Middle Section - Center Seal
 - 2 - Rear Molded Detail Section - Center Seal
 - 3 - Start At Each End Of Center Seal And Work Towards The Center Of the Seal - Firmly Press The Seal Into Place
-

Fig. 15 CENTER SEAL - HAND ROLLER

- 1 - Right Freedom Top Panel
- 2 - Hand Roller - Use Roller Adhere Butyl To The Panel - Important Step
- 3 - Center Seal

26. To make sure the front and rear molded ends of the center seal do not move out of place start at the ends of the seal, and carefully working toward the center of the seal, install the middle section of the center seal to the panel.
27. Once the middle section is attached to the panel, go back over the entire length of the middle section of the seal with your hand to ensure that the seal is firmly attached to the Freedom Top panel.
28. **IMPORTANT:** Complete the installation of the center seal by applying pressure with a roller to the new center seal. Make certain that the roller will not damage the new center seal.
29. **IMPORTANT:** Verify full adhesion of the entire new center seal to the Freedom Top panel. **THIS IS CRITICAL**

Front Molded Detail Section Install - Final Steps:

30. Add adhesive promoter to the surface of the front molded detail (flame tip area) where the gray foam will be attached to the seal. Allow the adhesive promoter to dry completely.
31. To the front molded detail, add a 30 mm x 75 mm hard GRAY foam patch ([Fig. 16](#)) from the Replacement Foam Kit to the underside of the panel covering the flame tip of the "D" shaped bulb ([Fig. 17](#)).

Fig. 16 ADD A GRAY FOAM PATCH TO DETAIL

- 1 - Adhesive Promoter - Apply To Flame Tip Rubber And Allow To Dry - Then Install Gray Foam Patch
- 2 - New Butyl Adhesive Flush To Right Freedom Top Panel Surface
- 3 - Front Molded Detail Section - Center Seal
- 4 - Foam Stuffer - 7 mm OD x 71 mm Length - Reference

Fig. 17 PRESS SEAL AND PATCH INTO PLACE

- 1 - Front Inboard Corner And Notch - Right Freedom Top Panel
- 2 - Smooth Flat Transition - Rubber Tab - Front Molded Detail
- 3 - Smooth Flat Transition - Pressed In Place - Gray Foam Patch with Adhesive Promoter Already Applied

32. Once the final steps are completed then inspect the front molded detail section of the center seal for proper installation (Fig. 18). The gray foam (with adhesive promoter) should be flush with the corner of the flame tip. The front molded detail contact to the panel should be correct.

Fig. 18 FRONT DETAIL CORRECTLY INSTALLED

- 1 - Middle Section - Firmly Pressed In Place - Center Seal
 - 2 - Front Molded Detail Section - Center Seal
 - 3 - Gray Foam Patch with Adhesive Promoter Already Applied - Flush To Edges Of Flame Tip - Front Molded Detail
 - 4 - Correct Front Molded Detail Seal Contact To Right Freedom Top Panel
-

Rear Molded Detail Section Install - Final Steps:

33. Make sure the rear molded detail contact with the panel is correct ([Fig. 19](#)).

Fig. 19 SEAL POSITION AT MOLDED DETAIL

- 1 - GOOD - BOTTOM EDGE OF MOLDED DETAIL TO COVER LIP ON FREEDOM PANEL
 - 2 - REAR MOLDED DETAIL
 - 3 - FREEDOM PANEL
 - 4 - BAD - BOTTOM EDGE OF MOLDED DETAIL IS TUCKED BEHIND LIP ON FREEDOM PANEL
-

34. Add adhesive promoter to the surface of the rear molded detail (flame tip area) where the black foam will be attached to the seal. Allow the adhesive promoter to dry completely.
35. Add a 30 mm x 75 mm BLACK foam patch from the Replacement Foam Kit to the under side of the panel covering the flame tip of the rear molded detail of the center seal. Make certain the corners and edge of the foam patch align with the outside edges of the flame tip ([Fig. 20](#)).

Fig. 20 ADD BLACK FOAM PATCH TO DETAIL

- 1 - Rear Molded Detail Section
 - 2 - Adhesive Promoter - Apply To Flame Tip Rubber And Allow To Dry - Then Install Black Foam Patch - Rear Molded Detail
-

36. Press the 30 mm x 75 mm BLACK foam patch to panel ([Fig. 21](#)).

Fig. 21 PRESS FOAM PATCH INTO PLACE

- 1 - Rear Inboard Corner and Notch - Right Freedom Top Panel
 - 2 - Black Foam Patch With Adhesive Promoter - Press Firmly In Place
 - 3 - Black Foam Patch - Flush With Edges Of Rear Molded Detail
-

37. Using a SHARP razor blade, carefully trim off the outer corner of the foam so that it conforms to the flame tip of the rear molded detail of the center seal (Fig. 22).

Fig. 22 TRIM OFF CORNER OF BLACK PATCH

- 1 - Remove Excess Foam - Trim To Edge Of Molded Detail - Black Foam Patch
 - 2 - Rear Molded Detail Section - Center Seal - Right Freedom Top Panel
 - 3 - Middle Section - Center Seal - Right Freedom Top Panel
-

Fig. 23 REAR MOLDED DETAIL FLAME TIP

- 1 - Flame Tip - Rear Molded Detail Section - Center Seal
 - 2 - Black Foam Patch With Adhesive Promoter Applied - Flush With Edges Of Flame Tip
 - 3 - Remove Excess Foam - Trim To Edge Of Molded Detail - Black Foam Patch
 - 4 - Rear Molded Detail Section - Center Seal
 - 5 - Middle Section - Center Seal
 - 7 - Notch in Rear Molded Detail Section - 5 mm x 15 mm - Reference
 - 8 - Correct Rear Molded Detail Seal Contact To Right Freedom Top Panel
-

38. Once the final steps are completed then inspect the rear molded detail section of the center seal for proper installation (Fig. 23). The black foam with adhesive promoter applied should be flush with the corner of the flame tip. The rear molded detail contact to the panel should be correct.
39. Move the right panel off to the side, onto a protected surface, while the left panel is being worked on. Later both panels will need to have their outboard corners inspected and repaired.

Left Freedom Top Panel:***Fig. 24 ADD BUTYL TO REAR INSIDE CORNER***

- 1 - Rear Inboard Corner - Left Freedom Top Panel
 - 2 - Hard Top Side (Rear) Surface - Left Freedom Top Panel
 - 3 - Install 100 mm Of New Butyl Adhesive (4 mm dia.) Into Groove At Edge Of Panel - Butyl To Be Flush To Top Of Groove
 - 4 - Install 70 mm Of New Butyl Adhesive (4 mm dia.) Into At Edge Of Panel - Butyl To Be Flush To Top Of Groove
 - 5 - Center Seal Side Surface - Left Freedom Top Panel
-

40. Move to the left Freedom Top panel. Locate the inboard rear corner of the left panel.
41. Clean ALL old butyl adhesive from the left panel inboard rear corner surface, notches, and grooves. Wipe the panel rear inboard corner surface clean with a high quality adhesive remover.

NOTE: ALL old adhesive, sealant, oils, debris MUST BE thoroughly removed from the panel surface and rear inboard corner notches / groove. Use the high quality adhesive remover and a small pick to remove the remaining old adhesive. Once the old adhesive has been removed, thoroughly clean and prep the entire rear inboard corner surface by removing any residual adhesive and oils with the high quality adhesive remover.

42. Add new butyl adhesive (4 mm in diameter) into the inboard rear corner outer groove of the left panel ([Fig. 24](#)). Apply the new butyl adhesive for 70 mm into the inboard side groove. Apply butyl adhesive for 100 mm into the rear groove. The new butyl adhesive must fill the inboard and rear grooves, but it must not overfill the groove (it must be even with the surface).

Fig. 25 ADD BLACK FOAM PATCH OVER BUTYL

- 1 - Rear Inboard Corner - Left Freedom Top Panel
 - 2 - New Butyl Adhesive Placed In Groove and Flush With Top Of Groove
 - 3 - Black Foam Patch (30 mm x 75 mm) - Install So It Is Flush With Edges Of Panel - Press In Place
-

43. Each foam patch must cover the butyl adhesive. Add one 30 mm x 75 mm BLACK foam patch over the new butyl along the inboard edge of the rear inboard corner. The butyl must not stick out from under the foam ([Fig. 25](#)).

Fig. 26 FOAM PATCHES COVERING BUTYL

- 1 - Rear Inboard Corner - Left Freedom Top Panel
 - 2 - Black Foam Patch (30 mm x 75 mm) - Install So It Is Flush With Edges Of Panel - Press In Place
 - 3 - Black Foam Patch (30 mm x 75 mm) - Install So It Is Flush With Edges Of Panel - Press In Place
-

44. Each foam patch must cover the butyl adhesive. Add one 30 mm x 75 mm BLACK foam patch over the new butyl along the rear edge of the rear inboard corner. The butyl must not stick out from under the foam (Fig. 26).

Replace Left Panel Header Latch:

45. If vehicle was built prior to December 17, 2007 (MDH 1217XX), then replace the left panel header latch (Fig. 1).

Outboard Corners - Both Freedom Top Panel:

Fig. 27 CHECK OUTSIDE CORNERS FOR FOAM

- 1 - Outboard Corner - Right or Left Freedom Top Panel - Rear Outboard Corner Shown
 - 2 - Black Foam Corner Patch - Used At: Front and Rear Outboard Corners - D-972-E for RIGHT Panel and D-973-E for LEFT Panel
 - 3 - Black Foam Patch D-1009-A - 20mm x 95mm x 5mm thick - Used At: Rear Outboard Corner (Lt And Rt Panels) to Hard Top Seal
 - 4 - Isolator - Black Plastic
-

46. With the **LEFT PANEL**, locate the rear outboard corner of the panel.
47. Note the location of the old foam patches. Remove the old foam patches from the rear outboard corner of the left panel.
48. Thoroughly clean all old adhesive residue from the rear outboard corner surface using a high quality adhesive remover.
49. Carefully install a new Black Foam Corner Patch to the rear outboard corner surface. Ensure that no wrinkles are in the foam patch.
50. Carefully install the Black Foam Patch (20mm x 95mm x 5mm) to the rear outboard corner surface. Ensure that no wrinkles are in the foam patch.
51. Move to the Front Outboard of the left panel.
52. Note the location of the old black foam corner patch. Remove the old foam patch.
53. Thoroughly clean all old adhesive residue from the front outboard corner surface using a high quality adhesive remover.
54. Carefully install a new Black Foam Corner Patch to the front outboard corner surface. Ensure that no wrinkles are in the foam patch.
55. Verify that the black plastic isolator is in place and not damaged. Replace the isolator if damaged or missing.
56. Verify that the alignment pin is in place and not damaged. Replace the alignment pin if damaged or missing. Dependent upon when the hard top panel was made there are different size alignment pins. Install the correct size diameter alignment pin.
57. Place the left panel to the side on a protected surface.
58. Place the **RIGHT PANEL** top facing down on the protected work surface.

59. Repeat the above step in this section, Outboard Corners - Both Freedom Top Panel, to the front and rear outboard corners.

Install Windshield Header Seal Stuffer:

Fig. 28 WINDSHIELD STUFFER LOCATION

- 1 - Bulb Where Rubber Stuffer Will Be Installed Under - Windshield Header Seal
- 2 - Rubber Stuffer (13 mm OD x 8 mm ID x 160 mm) - Install and Center Under Windshield Header Seal Bulb
- 3 - Make A Smooth 30 mm Cut Along Seam At Bottom Of Bulb - Install Rubber Stuffer Through Cut Opening

60. Move to the windshield header seal.
61. Locate the windshield header seal round stuffer (C-5165 - 13mm OD x 8mm ID x 160mm) from the Replacement Foam Kit.
62. Place the windshield header seal round stuffer to the windshield header seal bulb. Center the stuffer to the center of the windshield header seal ([Fig. 28](#)). Temporarily place a mark on the windshield center seal at each end of the stuffer. If a stuffer is already in place, then it will be replaced with this new stuffer.
63. Using a razor blade, a cut will be made into the windshield header seal bulb to allow placement of the stuffer inside of the windshield header seal bulb. The cut will be made along the bottom edge of the bulb. Mark a 30 mm length on the header seal bulb where the cut will be placed.
64. Where the right end of the stuffer will end, and along the bottom edge of the header seal bulb, **CAREFULLY** place a 30 mm cut through the header seal bulb material.
65. **CAREFULLY** install the stuffer into the windshield header seal. Take care not to tear the seal bulb material. Use a light water based lubricant to aid installation.
66. Glue the stuffer in place. Apply glue (Mopar Bond-All Gel) to the stuffer and inside surface of the header seal bulb.
67. **CAREFULLY** glue (using Mopar Bond-All Gel) the cut in the header seal bulb closed.

Fig. 29 WINDSHIELD SEAL CROSS SECTION

- 1 - Panel Interface With The Windshield Header Seal - Freedom Top Panel
- 2 - Location Of 30 mm Cut - Install Stuffer Through Cut Opening - Seal Cut With Glue
- 3 - Rubber Stuffer (13 mm OD x 8 mm ID x 160 mm) - Installed Inside Windshield Header Seal Bulb
- 4 - Cross Section - Windshield Header Seal
- 5 - Windshield Frame

Install Freedom Top Panels and Retest For Water Leaks:

68. Install the Freedom Panels to the hard top ([Fig. 1](#)). To ensure that the panels are installed correctly perform the following steps in order. **When installing each Freedom Panel always close the windshield latch first.**
 - a. With both panels removed, carefully install the right side panel onto the hard top.
 - b. Make sure the sun visor is folded down and out of the way.

- c. Latch the right header panel latch located at the top of the windshield.
 - d. Turn the right side panel rear L-shaped lock (located above the shoulder belt anchorage) so that it fully engages the hard top.
 - e. Turn the right side panel rear fastener knob (located on the overhead speaker bar assembly) clockwise until it is tight.
 - f. Carefully install the left side panel onto the hard top.
 - g. Make sure the sun visor is folded down and out of the way.
 - h. Latch the left header panel latch located at the top of the windshield.
 - i. Turn the left side panel rear L-shaped lock (located above the shoulder belt anchorage) so that it full engages the hard top.
 - j. Turn the left side panel rear fastener knob (located on the overhead speaker bar assembly) clockwise until it is tight.
 - k. Turn both center L-shaped locks (2) so that they fully engage the right side panel.
69. Retest to verify that the leak was corrected.

POLICY:

Reimbursable within the provisions of the warranty.

TIME ALLOWANCE:

Labor Operation No:	Description	Amount
23-51-41-90	Center Seal - Modular Top Water Leak - Replace (B)	A/T Hrs.

FAILURE CODE:

ZZ	Service Action
----	----------------



NUMBER: 23-025-08

GROUP: Body

DATE: August 26, 2008

This bulletin is supplied as technical information only and is not an authorization for repair. No part of this publication may be reproduced, stored in a retrieval system, or transmitted, in any form or by any means, electronic, mechanical, photocopying, or otherwise, without written permission of Chrysler LLC.

THIS BULLETIN SUPERSEDES TECHNICAL SERVICE BULLETIN 23-016-08, DATED May 24, 2007, WHICH SHOULD BE REMOVED FROM YOUR FILES. THIS IS A COMPLETE REVISION AND NO ASTERISKS HAVE BEEN USED TO HIGHLIGHT REVISIONS.

SUBJECT:

Freedom Top - Header Seal - Water Leak In Area Of Dash

OVERVIEW:

This bulletin involves the replacement of the header seal and its associated butyl adhesive.

MODELS:

2007 - 2008 (JK) Wrangler

NOTE: This bulletin applies to vehicles equipped with a Freedom Modular Hard Top (Sales code VK0). Vehicles equipped with Dual Tops (Soft Top and Freedom Top) should have this bulletin performed with the Freedom Top installed only (NOT THE SOFT TOP). The replacement header seal may initially cause a soft top wind noise.

SYMPTOM/CONDITION:

This bulletin will address water leaks due to the **FRONT HEADER SEAL** at the roof.

Water leaks associated with the header seal can cause the front floor and/or instrument panel to get wet. Water leaking into the vehicle at the B-Pillar or anywhere further back in the vehicle are not covered in this Service Bulletin. Water leaks in these areas are addressed in other Service Bulletins and eFiles. Refer to those Service Bulletins and eFiles as necessary.

NOTE: Refer to additional supporting material and pictures available in DealerCONNECT and TechCONNECT. Select eFiles > Service > Star Center > Misc Documents > JK A Pillar Water Leak Repair.

DIAGNOSIS:

1. Determine the vehicle build date. Vehicles equipped with a Freedom Modular Hard Top and built on or before **December 17, 2007** (MDH1217XX) will require the windshield header latch on each panel be replaced with the latest level latch.



Stick with the Specialists™

2. Visually inspect door to windshield frame (A-Pillar) fit. Door should be parallel to A-Pillar and surface flush to slightly under-flush.

NOTE: Vehicles equipped with Freedom Top panels must have the panels CORRECTLY installed. This is very important to prevent a water leak from occurring. Make sure the technician and customer know and use the correct removal and installation procedure. Follow the removal and installation steps in the Owners Manual.

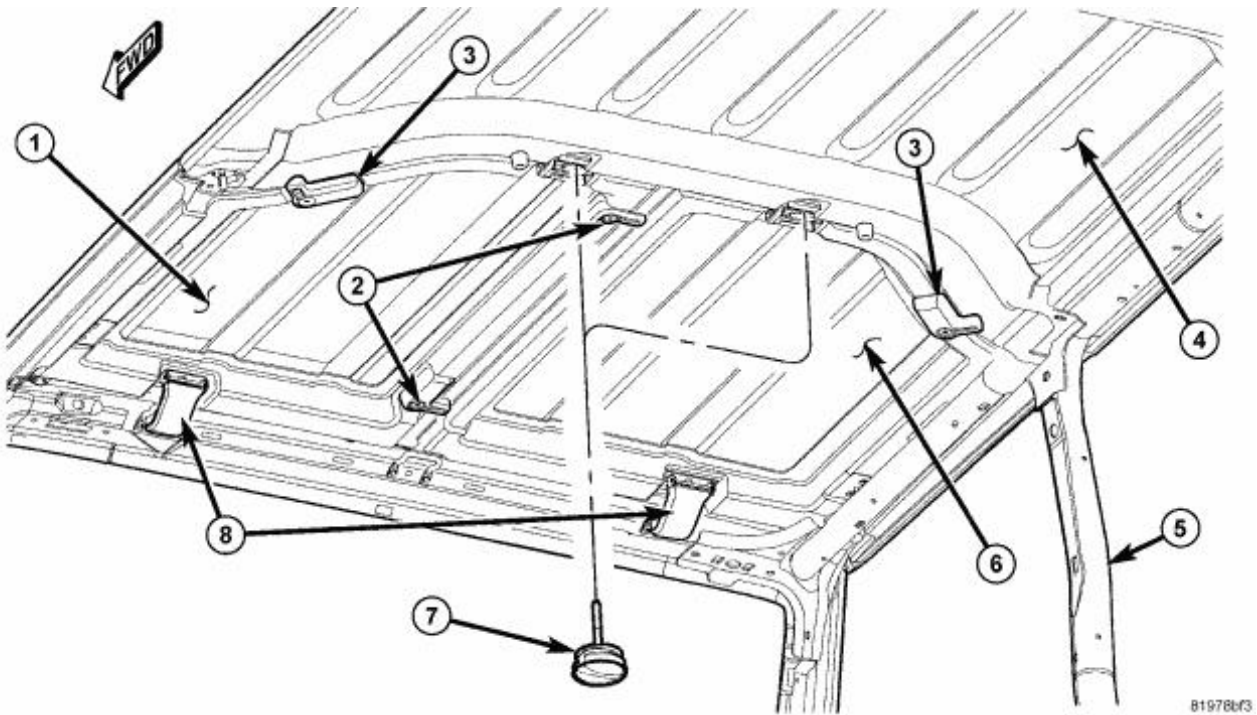

Fig. 1 HARD TOP INSIDE FULL VIEW

- 1 - Left Freedom Top Panel
- 2 - Center L-Shaped Locks - Left Freedom Top Panel
- 3 - Rear L-Shaped Lock at Seat Belt Anchorage - Left and Right Freedom Top Panel
- 4 - Hard Top
- 5 - B-Pillar
- 6 - Right Freedom Top Panel
- 7 - Rear Fastener (Dial) Knobs - Left and Right Freedom Top Panel
- 8 - Windshield Header Latch - Left and Right Freedom Top Panel

3. Inspect the Freedom Top panels to ensure that they are installed correctly (Fig. 1). If not, then note this condition so that the correct procedure for installing the Freedom Top panels to the hard top can be reviewed with the customer. To ensure that the panels are installed correctly perform the following steps in order. **When installing each Freedom Top panel, always close the windshield latch first.**
 - a. With both panels removed, carefully install the right side panel onto the hard top.
 - b. Make sure the sun visor is folded down and out of the way.
 - c. Latch the right header panel latch located at the top of the windshield.

- d. Turn the right side panel rear L-shaped lock (located above the shoulder belt anchorage) so that it fully engages the hard top.
 - e. Turn the right side panel rear fastener knob (located on the overhead speaker bar assembly) clockwise until it is tight.
 - f. Carefully install the left side panel onto the hard top.
 - g. Make sure the sun visor is folded down and out of the way.
 - h. Latch the left header panel latch located at the top of the windshield.
 - i. Turn the left side panel rear L-shaped lock (located above the shoulder belt anchorage) so that it full engages the hard top.
 - j. Turn the left side panel rear fastener knob (located on the overhead speaker bar assembly) clockwise until it is tight.
 - k. Turn both center L-shaped locks (2) so that they fully engage the right side panel.
4. Only after verifying Freedom Top is properly installed, Proceed to **Test For Water Leak(s)**.

Test For Water Leak(s)

- 1. Have an assistant apply a slow flow of water across the top header joint with a hose for approximately 3-5 minutes while inspecting the interior of the hard top for water leaks to determine general leak source location(s). Do not use a hard spray of water. Do not stop inspection when one leak source is located, there may be more than one water leak source.

NOTE: Dripping that occurs at the center of the windshield header may be the result of a Freedom Top seal leaking and running forward. The following step verifies leak origination point.

- 2. If leak occurs at the front of the top near the A-Pillar, remove the sun visors, upper and lower trim covers to gain visual access to the header seal. Water leaks originating from the header seal will generally run towards the outside ends of the header, (toward the A-Pillar) and drip in at the corner(s).
- 3. If a water leak is originating at the header seal, then perform the Repair Procedure in this Service Bulletin **and** refer to DealerCONNECT > eFiles > Service > Star Center > Misc. Documents > JK A Pillar Water Leaks, for additional information.

PARTS REQUIRED:

Qty.	Part No.	Description
AR (1)	55397454AD	Seal, Windshield Header (Freedom Top)
1 (AR)	82300508AB	Mopar Corrosion Inhibitor - 5 oz. Brush Top Tube (or equivalent)
AR (1)	08984 - 3M	General Purpose Adhesive Cleaner (or equivalent)
AR (1)	06396 - 3M	Adhesive Promoter 2.5 cc Packet (or Equivalent) Box of 25 (1 box will service 25 vehicles).
AR (6)	68027813AA	Butyl, Tape - 4 mm dia. x 152 mm (6 inch) length - strip

REPAIR PROCEDURE:

NOTE: Do not use RTV as a sealer. Over time RTV will not remain attached to the hard top material.

1. Remove both Freedom Top Panels from the hard top. Perform the following steps in order:
 - a. Fold both sun visors down and out of the way.
 - b. Turn both left panel center L-shaped locks (2) so that they disengage from the right side panel.
 - c. Turn the left panel rear L-shaped lock (located above the shoulder belt anchorage) so that it disengages from the hard top.
 - d. Turn the left panel rear fastener knob (located on the overhead speaker bar assembly) counter-clockwise until it can be removed.
 - e. Unlatch the left panel header panel latch located at the top of the windshield.
 - f. Carefully remove the left side panel from the hard top.
 - g. Turn the right panel rear L-shaped lock (located above the shoulder belt anchorage) so that it disengages from the hard top.
 - h. Turn the right panel rear fastener knob (located on the overhead speaker bar assembly) counter-clockwise until it can be removed.
 - i. Unlatch the right panel header panel latch located at the top of the windshield.
 - j. Carefully remove the right side panel from the hard top.
2. Set the Freedom Top panels on a well **PROTECTED WORK SURFACE**. Protect the Freedom Top panel edges & top surface from damage.

NOTE: THE PAINTED TOP SURFACE OF THE FREEDOM TOP CAN EASILY BE DAMAGED IF CARE IS NOT TAKEN TO PROTECT IT.

3. Verify Freedom Top has been updated with all of the proper foam and butyl parts as shown in SB # 23-020-08 Dated June 20, 2008. (Fig. 2) shows placement of these components.

If SB # 23-020-08 has not been completed and leaks are occurring at the windshield header, the Freedom Tops will require resealing in conjunction with the header seal replacement. Perform SB # 23-020-08 before proceeding with this bulletin.

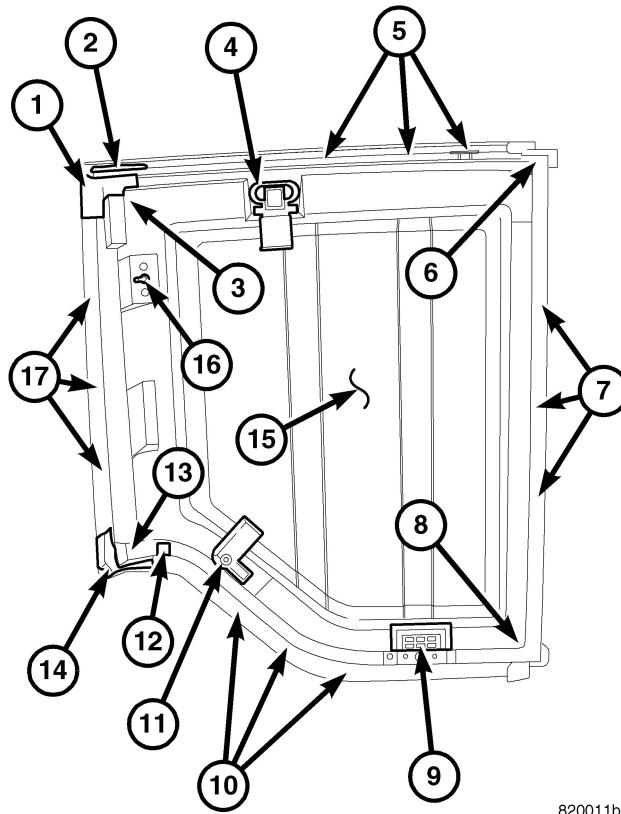

820011b3

Fig. 2 RIGHT FREEDOM PANEL COMPONENTS

- 1 - Black Foam Corner Patch D-972-E and Black Foam Patch D-1010-A - 30mm x 95mm x 3mm thick
- 2 - Gray Foam Strip D-1012 - 9mm x 100mm x 6.35mm thick
- 3 - Front Outboard Corner
- 4 - Windshield Header Latch
- 5 - Front Side Surface - Right Freedom Top Panel to Windshield Header Panel and Header Seal
- 6 - Front Inboard Corner, Front Molded Detail Section of Center Seal, and Gray Foam Patch C-5166 - 30mm x 75mm x 2mm thick
- 7 - Inboard Side Surface - Right Freedom Top Panel with Center Seal
- 8 - Rear Inboard Corner, Rear Molded Detail Section of Center Seal, and Black Foam Patch D-1011-A - 30mm x 75mm x 3mm thick
- 9 - Spacer Blocker and Rear Thumb (Dial) Screw Attachment
- 10 - Rear Side Surface - Right Freedom Top Panel to Hard Top and Hard Top Seal
- 11 - Rear L-Shaped Lock at Shoulder Belt Anchorage
- 12 - Isolator Pad - Black Plastic
- 13 - Rear Outboard Corner
- 14 - Black Foam Corner Patch D-972-E and Black Foam Patch D-1009-A - 20mm x 95mm x 5mm thick
- 15 - Right Freedom Top Panel
- 16 - Locator Pin - Diameter Sizes of: 6.0 mm, 8.0 mm, or 9.5 mm
- 17 - Outboard Side Surface - Right Freedom Top Panel to Door Seal, A-Pillar Cup, and B-Pillar Cup and Mocket

NOTE: Vehicles equipped with Dual Tops (Soft and Freedom Top) should have this bulletin performed with the Freedom Top installed. The replacement header seal may initially cause a soft top wind noise.

Replace Windshield Header Seal:

NOTE: If seal requires replacement, then the old seal adhesive must be completely removed before a new seal is installed. Use a GOOD quality adhesive remover as recommended in Parts Required section of this Service Bulletin.

4. Drill out rivets at each end of the header seal with 1/8" drill bit.
5. Remove header weatherstrip from body sheet metal.
6. Remove all traces of old tape and butyl from painted sheet metal on header. Use p/n 08984 - 3M General Purpose Adhesive Cleaner (or equivalent) to remove.
7. Treat surface with 06396 - 3M Adhesive Promoter pad (or equivalent). Allow to completely dry.
8. Install butyl to fill gaps in sheet metal or wrinkles, holes and notches in thumb sealer in the area describe in (Fig. 3).
9. Carefully smooth butyl to form a smooth transition to the header sheet metal.
10. Treat rivet hole bare metal with p/n 82300508, Mopar Corrosion Inhibitor.

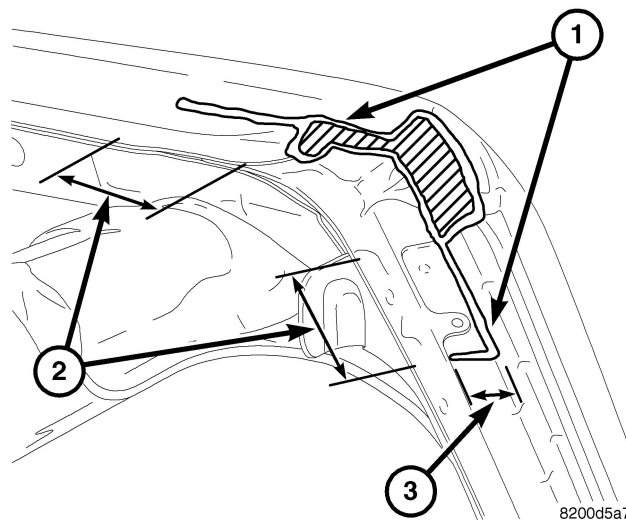

Fig. 3 BUTYL INSTALLATION DIMENSIONS

1 - Item_1

2 - Item_2

-
11. Before removing tape backing, lay the new header weatherstrip, p/n 55397454AD in place on header to align.
 12. Remove tape backing and press weatherstrip firmly to header sheet metal and smooth out adhesive tape.

NOTE: A small roller or firm finger pressure should be used to smooth tape and butyl.

13. Ensure the butyl is feathered out smooth and adhesive tape is pressed to make full contact. Work back and forth, from side to side.

- 14. Install the Freedom Panels to the hard top. To ensure that the panels are installed correctly perform the following steps in order. **When installing each Freedom Panel always close the windshield latch first.**
 - a. Make sure the sun visors is folded down and out of the way.
 - b. Carefully install the right side panel onto the hard top.
 - c. Latch the right header panel latch located at the top of the windshield.
 - d. Turn the right side panel rear L-shaped lock (located above the shoulder belt anchorage) so that it fully engages the hard top.
 - e. Turn the right side panel rear fastener knob (located on the overhead speaker bar assembly) clockwise until it is tight.
 - f. Carefully install the left side panel onto the hard top.
 - g. Latch the left header panel latch located at the top of the windshield.
 - h. Turn the left side panel rear L-shaped lock (located above the shoulder belt anchorage) so that it full engages the hard top.
 - i. Turn the left side panel rear fastener knob (located on the overhead speaker bar assembly) clockwise until it is tight.
 - j. Turn both center L-shaped locks (2) so that they fully engage the right side panel.
- 15. Retest to verify that the leak was corrected.

POLICY:

Reimbursable within the provisions of the warranty.

TIME ALLOWANCE:

Labor Operation No:	Description	Amount
23-51-35-97	Seal - Modular Top to Header, Replace due to A-Pillar Water Leak - (B)	1.2 Hrs.

FAILURE CODE:

ZZ	Service Action
----	----------------



NUMBER: 23-005-09 REV. A

GROUP: Body

DATE: August 12, 2009

This bulletin is supplied as technical information only and is not an authorization for repair. No part of this publication may be reproduced, stored in a retrieval system, or transmitted, in any form or by any means, electronic, mechanical, photocopying, or otherwise, without written permission of Chrysler Group LLC.

THIS BULLETIN SUPERSEDES TECHNICAL SERVICE BULLETINS 23-002-08, DATED JANUARY 15, 2008, 23-020-08, DATED JUNE 20, 2008, 23-025-08, DATED AUGUST 26, 2008, AND 23-005-09, DATED MARCH 24, 2009 WHICH SHOULD BE REMOVED FROM YOUR FILES. THIS IS A COMPLETE REVISION AND NO ASTERISKS HAVE BEEN USED TO HIGHLIGHT REVISIONS.

SUBJECT:

Hard Top / Soft Top Water Leak Diagnosis

OVERVIEW:

This bulletin introduces a New Water Leak Repair Manual that should be followed whenever a vehicle is brought in with water leak concerns.

MODELS:

2007 - 2009 (JK) Wrangler

NOTE: This bulletin applies to vehicles equipped with a soft top, dual top and targa top (sales code GWK, VJ0, AEM and VJX).

SYMPTOM/CONDITION:

Water leaks from hard or soft top and water on the carpet.

DIAGNOSIS:

A new approach to addressing water leak concerns on Wrangler models has been developed and is announced with this Service Bulletin. The New Manual can be accessed through DealerCONNECT > Efiles. The file is found in the Service section > STAR Center > Misc Documents > JK Water Leak Repair Manual. The manual provides detailed color graphics and instructions to address many of the leak concerns associated with the Soft or Hard top models. The manual is broken out by leak category (as listed below) and provides all the necessary information and latest methods to make effective repairs. The Labor Operations listed in the Service Bulletin can be used based on repair methods used in the manual.

The JK Water Leak Repair Manual has a diagnosis road map that includes the following customer concerns:

- i. Water is on center of Instrument Panel / Shifter
- ii. Water is on door trim panel or Instrument Panel at A-pillar
- iii. Water at rear hard top panel / B-pillar
- iv. Water is on the front carpet



Stick with the Specialists™

POLICY:

Reimbursable within the provisions of the warranty.

TIME ALLOWANCE:

Labor Operation No:	Description	Amount
23-51-35-95	Diagnosis Top System for Water Leaks (B)	0.4Hrs.
23-51-35-97	Inspect and Replace Windshield Header Seal (B)	0.9Hrs.
23-51-10-90	Measure and Adjust Door Fit and Replace Primary Door Seal - One Door Only (B)	0.7Hrs.
23-51-41-91	Inspect A-Pillar Mocket Seal - One Side Only (B)	0.4Hrs.
23-51-41-92	Reseal Freedom Tops - Both Freedom Panels (B)	0.5Hrs.
23-42-63-90	Latch Freedom Panels - Both Right & Left Freedom Panels (B)	0.5Hrs.
23-51-35-98	Replace Hard Top Seal (B)	0.8Hrs.
23-51-41-93	Replace B-Pillar Mocket Seal - One Side Only (B)	0.4Hrs.
23-50-35-90	Repair Rear Wheel Flare Holes - Both Sides Right and Left Sides (B)	0.7Hrs.
23-50-40-90	Reseal Cowl Side Panel - One Side Only (B)	0.5Hrs

FAILURE CODE:

ZZ	Service Action
----	----------------